

Steel Tubing

For supply and feedlines.

Part No.	Size (O.D. x Wall)			Working Pressure	Type
	O.D. in.	Wall in.	Length ft. / m		
62175	1/8	.020	25 / 7.6	4400 psig / 300 bar	Coil
62176	1/4	.028	25 / 7.6	2800 psig / 190 bar	coil
62249	3/8	.028	25 / 7.6	1850 psig / 126 bar	coil

Type 304 Stainless Steel Tubing

For supply and feedlines. For corrosive environments. ASTM A-269 specs.

Part No.	Size (O.D. x Wall)			Working Pressure	Type
	O.D. in.	Wall in.	Length ft. / m		
62948-9	1/8	.028	20/ 6.1	9000 psig / 612 bar	coil
62949-9	1/4	.028	20/ 6.1	4480 psig / 305 bar	coil
62950-9	3/8	.028	20/ 6.1	2980 psig / 203 bar	coil

Nylon Tubing

For feedlines. Temperature range -65°F to 150°F.

Part No.	Size (O.D. x Wall)			Working Pressure	Minimum Bend Radius in.
	O.D. in.	Wall in.	Length ft. / m		
62256	1/8	.026	25 / 7.6	625 psig / 42.5 bar	.375
62278			100 / 30.5		
62956			500 / 152		
62357	1/4	.050	100 / 30.5		.875
247022			500 / 152		

Single and Multiple Tube Clamps

For feedlines.

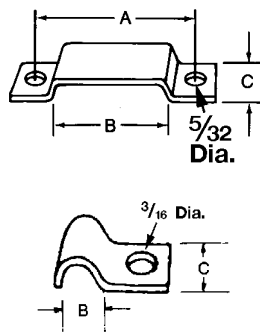

Clamp No.	Const.	No. Tubes	Tube Size in.	A in.	B in.	C in.	Screw No.	Screw Descrip.	
64532-1	Steel	1	1/8 OD	—	1/8	1/2	66202	No. 6 roundhead 1/4" LG, Use No. 30 drill	
64532-2		2		1 1/16	1/4	3/8			
64532-3		3		1 3/16	3/8	3/8			
64532-4		4		1 5/16	1/2	3/8			
64532-5		5		1 1/8	5/8	3/8			
64533-1		1	2	1/4 OD	—	1/4			1/2
64533-2					1 5/16	1/2			3/8
64533-3					1 3/16	3/4			3/8
64533-4					1 7/16	1			3/8
64533-5					1 11/16	1 1/4			3/8
69159-9	Type 303 Stainless Steel	1	1/8 OD	—	1/8	3/8	66202-9		
69160-9		2		1 1/16	1/4	3/8			
69161-9		3		1 3/16	3/8	3/8			
69163-9		5		1 1/8	5/8	3/8			

Single Tube Clamps

For supply lines.

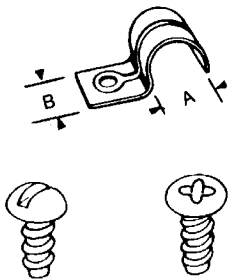

Clamp No.	Const.	Tube Size in.	A in.	B in.	Screw No.	Screw Description
360108	Steel	3/8 OD	3/8	1/2	66872	No. 10 round head, self-tapping 1/4" LG, use No. 17 drill
69164-9	Type 303	1/4 OD	1/4	3/8	66202-9	No. 6 round head, self-tapping 1/4" LG, use No. 30 drill
69165-9	Stainless Steel	3/8 OD	3/8	1/2	66872-9	No. 10 round head, self-tapping 1/4" LG, use No. 17 drill

Note: Screws listed in above tables. Order separately.

P Clamps

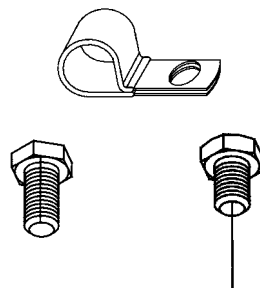

Clamp No.	Description	Material	Width in.	Length in.	Screw Description
249853	1 3/16" P style clamp	CRS	1	2 7/32	Use 249848 or 249849 bolts
249913	3/8" P style clamp	CRS	1		
270931	3/4" P style clamp	CRS	1	2 3/16	

Spring Coil

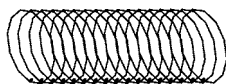

Clamp No.	Description	Material	Width in.	Screw Description
272598	25' spring coil	Steel	5/8 ID	Use 249848 or 249849 bolts

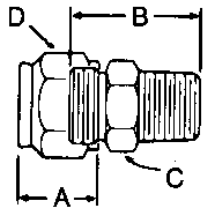

Heavy-Duty Tube Fittings—Male Connector

Tube to male pipe thread. For supply lines. Carbon steel unless noted (*) otherwise.

Part No.	Tube O.D. in.	Pipe Thread in.	A in.	B in.	Hex. C in.	Hex. D in.	Working Press. psig / bar
69068	1/4	1/8 NPT	19/32	61/64	1/2	5/8	5000 / 340
* 69068-9	3/8	1/8 NPT	19/32	61/64	1/2	5/8	5000 / 340
69069	1/4	1/4 NPT	19/32	15/32	5/8	5/8	5000 / 340
* 69069-9	1/4	1/4 NPT	19/32	15/32	5/8	5/8	5000 / 340
69070	3/8	1/8 NPT	3/4	1	5/8	3/4	5000 / 340
69071	3/8	1/4 NPT	3/4	1 13/64	5/8	3/4	5000 / 340
69072	3/8	3/8 NPT	3/4	1 13/64	3/4	3/4	5000 / 340

* 316 Stainless Steel

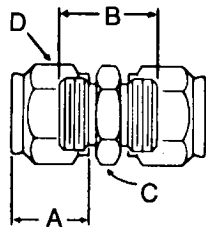

Heavy-Duty Tube Fittings—Union Connector

Tube to tube. For supply lines. Carbon steel unless noted (*) otherwise.

Part No.	Tube O.D. in.	A in.	B in.	Hex. C in.	Hex. D in.	Working Press. psig / bar
69078	3/8	3/4	1 1/16	5/8	3/4	6000 / 400

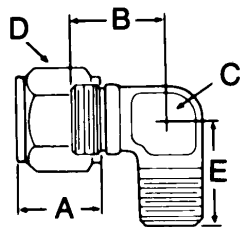

Heavy-Duty Tube Fittings—Male Elbow

Tube to male pipe thread. For supply lines. Carbon steel unless noted (*) otherwise.

Part No.	Tube O.D. in.	Pipe Thd. in.	A in.	B in.	Flats C in.	Hex. D in.	E in.	Working Press. psig / bar
* 69079-9	1/4	1/8 NPT	19/32	3/4	7/16	5/8	25/32	5000 / 340
69082	3/8	1/4 NPT	3/4	59/64	9/16	3/4	1 3/32	5000 / 340
* 69082-9	3/8	1/4 NPT	3/4	59/64	9/16	3/4	1 3/32	5000 / 340

* 316 Stainless Steel

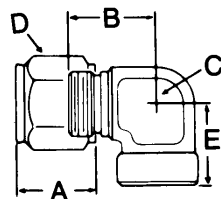

Heavy-Duty Tube Fittings—Female Elbow

Tube to female pipe thread. For supply lines. Carbon steel unless noted (*) otherwise.

Part No.	Tube O.D. in.	Pipe Thd. in.	A in.	B in.	Flats C in.	Hex. D in.	E in.	Working Press. psig / bar
69084	1/4	1/8 NPT	19/32	25/32	1/2	5/8	1 1/16	5000 / 340
* 69085	1/4	1/4 NPT	19/32	1	3/4	5/8	7/8	5000 / 340

* 316 Stainless Steel

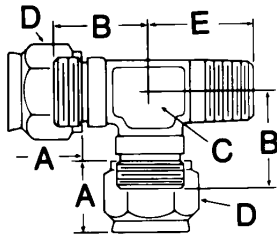

Heavy-Duty Tube Fittings—Male Run Tee

Tube to male pipe thread to tube. For supply lines. Carbon steel unless noted (*) otherwise.

Part No.	Tube O.D. in.	Pipe Thd. in.	A in.	B in.	Flats C in.	Hex. D in.	E in.	Working Press. psig / bar
69089	1/4	1/4 NPT	19/32	25/32	1/2	5/8	19/16	5000 / 340

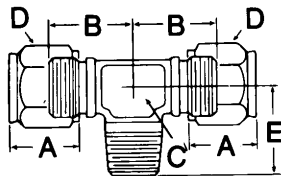

Heavy-Duty Tube Fittings—Male Branch Tee

Tube to tube to male pipe thread. For supply lines. Carbon steel unless noted (*) otherwise.

Part No.	Tube O.D. in.	Pipe Thd. in.	A in.	B in.	Flats C in.	Hex. D in.	E in.	Working Press. psig / bar
69093	3/8	1/4 NPT	3/4	63/64	5/8	3/4	1 1/16	5000 / 340

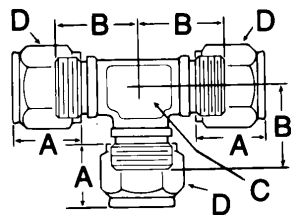

Heavy-Duty Tube Fittings—Union Tee

Tube to tube to tube. For supply lines. Carbon steel unless noted (*) otherwise.

Part No.	Tube O.D. in.	A in.	B in.	Flats C in.	Hex. D in.	Working Press. psig / bar
69094	1/4	19/32	3/4	7/16	5/8	5000 / 340
69095	3/8	3/4	63/64	5/8	3/4	5000 / 340

* 316 Stainless Steel

Heavy-Duty Tube Fittings—Sleeve

For supply lines. Carbon steel unless noted (*) otherwise.

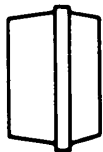

Part No.	Tube O.D. in.
69098	1/4
69099	3/8

* 316 Stainless Steel

Standard-Duty Tube Fittings—Male Connector

Tube to male pipe thread. For supply and feed lines. Brass unless noted (*) otherwise.

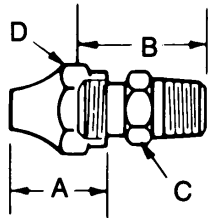

Part No.	Tube O.D. in.	Pipe Thd. in.	A in.	B in.	Hex. C in.	Hex. D in.	Working Press. psig / bar
66200	1/4	1/8 NPT	3/4	7/8	7/16	9/16	2000 / 136
66211	1/4	1/4 NPT	3/4	1 1/16	9/16	9/16	2000 / 136
68415	3/8	1/8 NPT	7/8	3 1/32	9/16	1 1/16	2000 / 136
66846	3/8	1/4 NPT	7/8	1 5/32	9/16	1 1/16	2000 / 136
* 69169-9	1/8	1/8 NPT	3 3/64	2 7/32	7/16	1/2	2000 / 136

* 316 Stainless Steel

Standard-Duty Tube Fittings—Female Connector

Tube to female pipe thread. For supply and feed lines. Brass unless noted (*) otherwise.

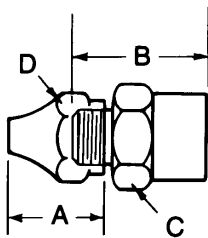

Part No.	Tube O.D. in.	Pipe Thd. in.	A in.	B in.	Hex. C in.	Hex. D in.	Working Press. psig / bar
68943	1/4	1/8 NPT	3/4	2 5/32	9/16	9/16	2000 / 136

Standard-Duty Tube Fittings—Male Elbow

Tube to male pipe thread. For supply and feed lines. Brass unless noted (*) otherwise.

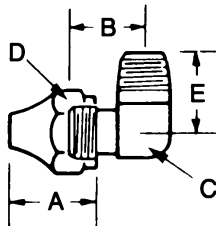

Part No.	Tube O.D. in.	Pipe Thd. in.	A in.	B in.	Flats C in.	Hex. D in.	E in.	Working Press. psig / bar
66201	1/4	1/8 NPT	3/4	1 9/32	7/16	9/16	2 3/32	2000 / 136
66210	1/4	1/4 NPT	3/4	5/8	9/16	9/16	3/4	2000 / 136
68412	3/8	1/8 NPT	7/8	1 1/16	9/16	1 1/16	1 1/16	2000 / 136
66762	3/8	1/4 NPT	7/8	2 3/32	9/16	1 1/16	2 9/32	2000 / 136
68414	3/8	3/8 NPT	7/8	2 7/32	1 1/16	1 1/16	3 1/32	2000 / 136
* 69166-9	1/8	1/8 NPT	3 3/64	2 1/32	7/16	1/2	3/4	2000 / 136

* 316 Stainless Steel

Standard-Duty Tube Fittings—Male Run Tee

For supply and feed lines. Brass unless noted (*) otherwise. Tube to male pipe thread to tube.

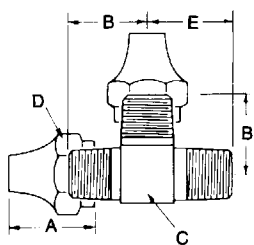

Part No.	Tube O.D. in.	Pipe Thd. in.	A in.	B in.	Flats C in.	Hex. D in.	E in.	Working Press. psig / bar
68615	1/4	1/8 NPTF	3/4	2 1/32	7/16	9/16	2 3/32	2000 / 136

Standard-Duty Tube Fittings—Male Branch Tee

Tube to tube to male pipe thread. For supply and feed lines. Brass unless noted (*) otherwise.

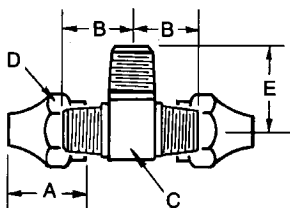

Part No.	Tube O.D. in.	Pipe Thd. in.	A in.	B in.	Flats C in.	Hex. D in.	E in.	Working Press. psig / bar
66651	1/4	1/8 NPTF	3/4	2 1/32	7/16	9/16	2 3/32	2000 / 136
66876	3/8	1/4 NPTF	7/8	2 5/32	9/16	1 1/16	2 9/32	2000 / 136

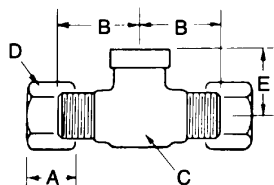

Standard-Duty Tube Fittings—Female Branch Tee

Tube to tube to female pipe thread. For supply and feed lines. Brass unless noted (*) otherwise.

Part No.	Tube O.D. in.	Pipe Thd. in.	A in.	B in.	Flats C in.	Hex. D in.	E in.	Working Press. psig / bar
67374	3/8	1/4 NPTF	3/4	1 1/16	3/4	1 1/16	7/8	2000 / 136

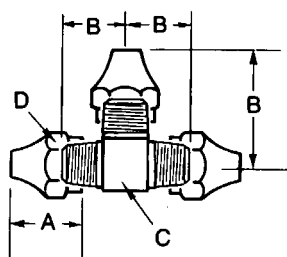

Standard-Duty Tube Fittings—Union Tee

Tube to tube to tube. For supply and feed lines. Brass unless noted (*) otherwise.

Part No.	Tube O.D. in.	A in.	B in.	C in.	Hex. D in.	Working Press. psig / bar
66650	1/4	3/4	5/8	7/16	9/16	2000 / 136
66878	3/8	7/8	23/32	9/16	1 1/16	2000 / 136

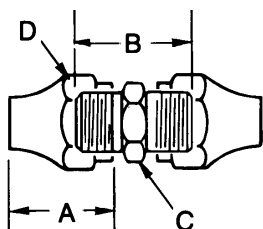

Standard-Duty Tube Fittings—Union

Tube to tube. For supply and feed lines. Brass unless noted (*) otherwise.

Part No.	Tube O.D. in.	A in.	B in.	Hex. C in.	Hex. D in.	Working Press. psig / bar
68468	1/4	3/4	25/32	7/16	9/16	2000 / 136

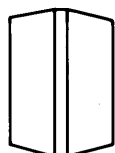

Standard-Duty Tube Fittings—Sleeve

For supply and feed lines. Carbon steel unless noted (*) otherwise. Included with all standard duty fittings.

Part No.	Tube O.D. - in.
68462	1/4
68463	3/8
* 69170-9	1/8

* 316 Stainless Steel



Standard-Duty Tube Fittings—Nut

For supply and feed lines. Carbon steel unless noted (*) otherwise. Included with all standard duty fittings.

Part No.	Tube O.D. in.	A in.	Hex. D in.
68464	1/4	3/4	9/16
* 69171-9	1/8	33/64	1/2

* 316 Stainless Steel

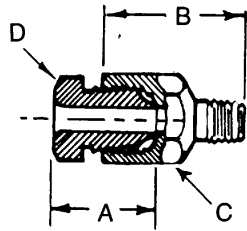

Threaded Sleeve Tube Fittings—Straight

Tube to male thread. For feed lines. Carbon steel with brass nut unless noted (*) otherwise.

Part No.	Tube O.D. in.	Thread in.	A in.	B in.	Hex. C in.	Hex. D in.	Working Press. psig / bar
66771	1/8	10-32	1/2	11/16	3/8	5/16	500 / 34
66714	1/8	1/4-28	1/2	5/8	3/8	5/16	500 / 34
* 66714-9	1/8	1/4-28	1/2	5/8	3/8	5/16	500 / 34
66772	1/8	1/4-28	1/2	11/16	3/8	5/16	500 / 34
66730	1/8	5/16-32	1/2	11/16	3/8	5/16	500 / 34
66773	1/8	3/8-24	1/2	11/16	7/16	5/16	500 / 34
66415	1/8	1/8 NPTF	1/2	5/8	7/16	5/16	500 / 34

* 303 Stainless Steel

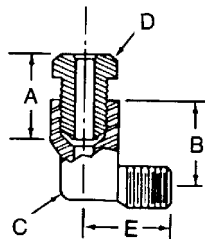

Threaded Sleeve Tube Fittings—90° Elbow

Tube to male thread. For feed lines. Brass with brass nut unless noted (*) otherwise.

Part No.	Tube O.D. in.	Thread in.	A in.	B in.	Flats C in.	Hex. D in.	E in.	Working Press. psig / bar
66716	1/8	1/4-28	1/2	1/2	13/32	5/16	33/64	500 / 34
66414	1/8	1/8 NPTF	1/2	1/2	7/16	5/16	21/32	500 / 34

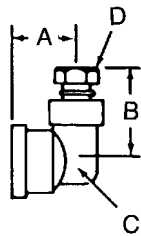

Threaded Sleeve Tube Fittings—90° Elbow

Tube to female pipe thread. For feed lines. Brass with brass nut unless noted (*) otherwise.

Part No.	Tube O.D. in.	Pipe Thd. in.	A in.	B in.	Flats C in.	Hex. D in.	Working Press. psig / bar
66935	1/8	1/8 NPT	23/32	11/32	3/8	5/16	500 / 34

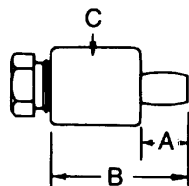

Threaded Sleeve Tube Fittings—Drive-Type

For feed lines. Steel body with brass nut.

Part No.	Hole Size in.	Tube O.D. in.	A in.	B in.	Dia. C in.	Hex. D in.	Working Press. psig / bar
82092	3/16	1/8	13/64	45/64	7/16	5/16	500 / 34

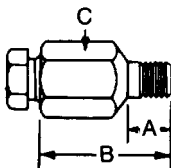

Threaded Sleeve Tube Fittings—Spin-Drive Type

For feed lines. Steel body with brass nut.

Part No.	Hole Size in.	Tube O.D. in.	A in.	B in.	Hex. C in.	Hex. D in.	Working Press. psig / bar
82093	1/4	1/8	5/32	5/8	7/16	5/16	500 / 34

Threaded Sleeve Tube Fittings—Compression Nuts

For feed lines. Brass unless noted (*) otherwise.

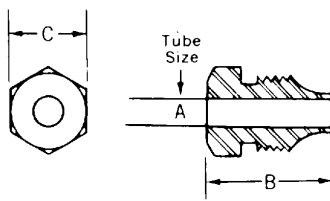

Part No.	A Tube Size O.D. in.	B in.	C in.	Working Press. psig / bar
66260	1/8	1/2	5/16	500 / 34
* 66260-9	1/8	1/2	5/16	500 / 34
66713	1/4	5/8	7/16	500 / 34

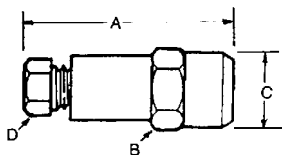

Snap-on Coupler Tube Fittings—Straight

Connect tubing to existing hydraulic (grease) fittings. Aluminum body, brass nut, Buna N packing.

Part No.	Tube O.D. Size in.	A in.	B Hex in.	C in.	D Hex in.	Working Press. psig / bar
* 82617	1/8	1.18	7/16	.43	1/4	500 psi / 34 bar
** 241389	1/4	1.69	5/8	.43	7/16	

* Uses Model 13112 compression nut (included). **Uses 66713 compression nut (included).

Note: Coupling to grease fitting is a permanent connection.

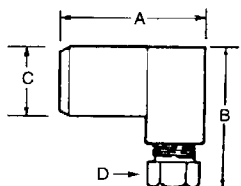

Snap-on Coupler Tube Fittings—90° Elbow

Connect tubing to existing hydraulic (grease) fittings. Aluminum body, brass nut, Buna N packing.

Part No.	Tube O.D. Size in.	A in.	B Hex in.	C in.	D Hex in.	Working Press. psig / bar
* 82618	1/8	.83	.86	.43	1/4	500 psi / 34 bar
** 241388	1/4	1.03	1.18	.43	7/16	

* Uses Model 13112 compression nut (included). **Uses 66713 compression nut (included).

Note: Coupling to grease fitting is a permanent connection.

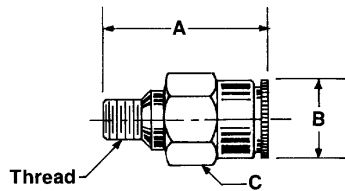

Quicklinc™ Tubing Adapter—Male Straight

Use with ¼" O.D. non-metallic tube for quick installation. Tubing simply pushes into place without ferrules or flairs. Nickel plated brass construction.

Part No.	Tube O.D. Size - in.	Thread	Dimensions - in. / mm			Max. Oper. Pressure
			A	B	C-Hex	
244047	¼	⅛" NPTF	.984 / 25	.460 / 11.7	.472 / 12	250 psig 17 bar
244055		¼" -28	.784 / 19.9			
244057		M6 X 1-6G Tapered	.965 / 24.5			

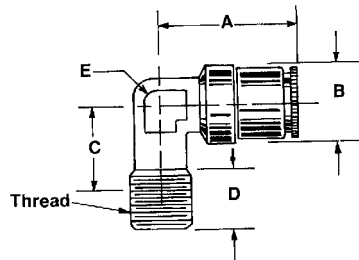

Quicklinc™ Tubing Adapter—Male 90° Elbow, Non-Swivel

Use with ¼" O.D. non-metallic tube for quick installation. Tubing simply pushes into place without ferrules or flairs. Nickel plated brass construction.

Part No.	Tube O.D. Size - in.	Thread	Dimensions - in. / mm					Max. Oper. Pressure
			A	B	C	D	E-Flat	
244048	¼	⅛" NPTF	.905 / 23	.500 / 12.7	.531 / 13.5	.374 / 9.5	.394 / 10	250 psig 17 bar
244054		¼" -28				.172 / 4.4		
244056		M6 X 1-6G Tapered				.590 / 15		

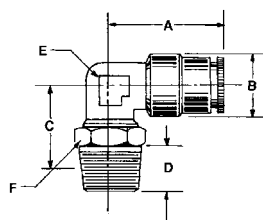

Quicklinc™ Tubing Adapter—Male 90° Elbow, Swivel

Use with ¼" O.D. non-metallic tube for quick installation. Tubing simply pushes into place without ferrules or flairs. Nickel plated brass construction.

Part No.	Tube O.D. Size in.	Thread	Dimensions - in. / mm						Max. Oper. Pressure
			A	B	C	D	E-Flat	F-Hex	
243699	¼	⅛" NPTF	.905 / 23	.500 / 12.7	.728 / 18.5	.374 / 9.5	.354 / 9	.472 / 12	250 psig 17 bar
244053		¼" - 28							

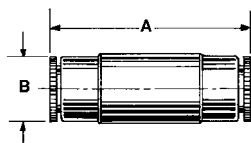

Quicklinc™ Tubing Adapter—Tube Union

Use with ¼" O.D. non-metallic tube for quick installation. Tubing simply pushes into place without ferrules or flairs. Nickel plated brass construction.

Part No.	Tube O.D. Size in.	Dimensions - in. / mm		Max. Oper. Pressure
		A	B	
244058	¼	1.397 / 35.5	.460 / 11.7	250 psig 17 bar

Supply Line and Material Hose

Type	I.D. in.	Wire Braid	Working Pressure	Min. Burst Pressure	Fittings in.	Min. Bend Radius in.	Part No.	Length	
								in.	cm
75 High Pressure	1/4	Double	5000 psig / 340 bar	20000 psig / 1360 bar	1/2 -27 female	4	75024	24	
							75060	60	
							75084	84	
							75120	120	
							75168	168	
							75240	240	
							75360	360	
							75480	480	
759 High Pressure	3/16	Double	4500 psig / 306 bar		1/8 NPT male	2 1/2	75948	48	122
							75960	60	152
76B High Pressure	3/8	Double	4000 psig / 272 bar	16000 psig / 1088 bar	1/2 NPT female	5	76024B	24	61
							76600B	600	1525
76A High Pressure	1/2	Double	3500 psig / 238 bar	14000 psig / 952 bar	1/2 NPT female	7	76900B	900	2288
							76024A	24	61
76600A	600	1525							
79 Volume Med. Pressure	3/8	Double	2250 psig / 153 bar	9000 psig / 612 bar	3/8 NPT male	5	79060	60	152.4
73 Med. Pressure	1/2	Single	1000 psig / 68 bar	4000 psig / 68 bar	1/2 NPT male		73024	24	61
							73036	36	91.4
							73060	60	152.4
							73120	120	305
							73240	240	610
							73360	360	915
							73480	480	1220
							73600	600	1525
73900	900	2288							
78 Med. Pressure	5/8	Single	1500 psig / 102 bar	6000 psig / 408 bar			78600	600	1525
1230 Med. Pressure	3/4	Double	2250 psig / 153 bar	9000 psig / 612 bar	3/4 NPT male		1230120	120	305

Note: Refer to Design Guides for the correct hose for your system.

Feed Line Hose (SAE 30R-3 Type)

For flexible connections between lube outlets, anchor blocks, swivels, tube connectors and bearings. Hose is $\frac{3}{16}$ " I.D. x $\frac{3}{8}$ " O.D.

Series 71900

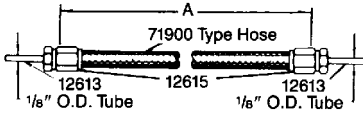

Part No.	Connections in.	Working Pressure	Min. Bend Radius in.	Length "A"	
				in.	cm
71908	$\frac{1}{8}$ O.D. tube x $\frac{1}{8}$ O.D. tube	500 psig / 34 bar	2	8	20.3
71912				12	30.5
71918				18	45.7

Series 82238

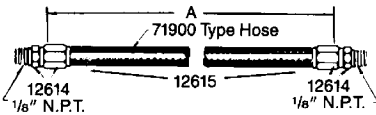

Part No.	Connections in.	Working Pressure	Min. Bend Radius in.	Length "A"	
				in.	cm
82238-12	$\frac{1}{8}$ NPTF(M) x $\frac{1}{8}$ NPTF(M)	500 psig / 34 bar	2	12	30.5
82238-18				18	45.7
82238-24				24	61

Series 81712

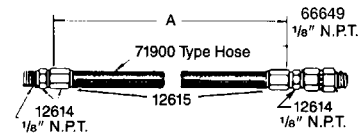

Part No.	Connections in.	Working Pressure	Min. Bend Radius in.	Length "A"	
				in.	cm
81712-6	$\frac{1}{8}$ NPTF(M) x #66649 Adapter Union $\frac{1}{8}$ NPTF(M)	500 psig 34 bar	2	6	15.2
81712-8				8	20.3
81712-18				18	45.7
81712-24				24	61
81712-30				30	76.2
81712-36				36	91.4

Series 82239

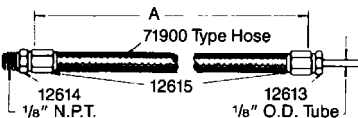

Part No.	Connections in.	Working Pressure	Min. Bend Radius in.	Length "A"	
				in.	cm
82239-12	$\frac{1}{8}$ O.D. tube x $\frac{1}{8}$ NPTF(M)	500 psig / 34 bar	2	12	30.5
82239-18				18	45.7
82239-24				24	61

Bulk Feed Line Hose and Fittings

Cut to required length and install connector fittings with standard wrenches.
SAE 30R3 type hose. Temperature range -40°F to 212°F.

Bulk Type 71900 Hose

Part No.	Size		Working Pressure	Min. Bend Radius in.	Length ft. / m
	I.D. - in.	O.D. - in.			
66844	3/16	3/8	500 psig / 34 bar	2	25 / 7.6
71900					Specify length

Fittings for 71900 Hose

Part No.	Construction	Description	Size - in.
12613	Steel	Hose Stud	1/8 O.D. tube x 1/4 -28male
12614			1/8 NPTmale x 1/4 -28male
13003			1/4 -28male x 1/4 -28male
12720			1/8 O.D. tube x 1/4 -28male, 90° angle
* 12615		Coupling Nut	1/4 -28 female
12613-9	Type 303 Stainless Steel	Hose Stud	1/8 O.D. tube x 1/4 -28male
12614-9			1/8 NPTmale x 1/4 -28male
* 12615-9		Coupling Nut	1/4 -28 female

* One coupling nut required for each hose stud.

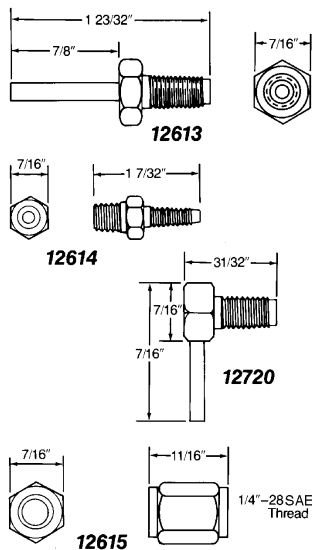

Air Hose

Connect system to compressed air supply.

Part No.	Length ft.	Specifications			Maximum Pressure		Braid
		I.D. in.	O.D. in.	Thread in.	Working	Burst	
72024	2	1/4	5/8	1/4 NPT male	250 psig / 17 bar	1250 psig / 85 bar	2-Ply Rayon
72036	3						
72060	5						
72120	10						
72240	20						
72480	40						
72600	50	23/32	3/8 NPT male	1/2 NPT male	200 psig / 14 bar	800 psig / 55 bar	1-Ply Rayon
72024A	2						
72360A	30						
72480A	40						
72600A	50						
72720A	60	1/2	1/2 NPT male	1/2 NPT male	200 psig / 14 bar	800 psig / 55 bar	1-Ply Rayon
74024	2						
74060	5						
74480	40						
74600	50						



Heavy-Duty Air Line Quick Disconnects

Rugged, high flow industrial design steel couplers and nipples.

Part No.	Description	Size	Max. Air Pressure
For 3/8" I.D. Hose			
645006	Coupler	3/8" NPT F	300 psig / 20 bar
For 1/2" I.D. Hose			
655008	Coupler	1/2" NPT F	300 psig
655012	Coupler	3/4" NPT F	
653112	Nipple	3/4" NPT M	20 bar
For 3/4" I.D. Hose			
662012	Coupler	3/4" NPT F	300 psig
660112	Nipple	3/4" NPT M	20 bar

Pipe Fittings—Reducing Bushings

For supply and feed lines.

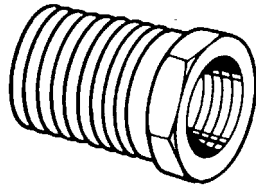

Part No.	Thread / in.	Construction
10461	1/8 NPTF female x 1/4 NPTF male	Steel
10200	1/8 NPTF female x 1/2-27 NPTF male	Brass
11229	1/4 NPTF female x 1/8 NPTF male	Steel
11348	1/4 NPTF female x 1/4 NPTF male	Steel
20011	1/4 NPTF female x 3/8 NPTF male	Steel
12080	1/4 NPTF female x 1/2 NPTF male	Steel
10204	1/4 NPTF female x 1/2-27 NPTF male	Brass
10049	3/8 NPTF female x 1/4 NPTF male	Steel
67069	3/8 NPTF female x 1/2 NPTF male	Steel
67198	3/8 NPTF female x 3/4 NPTF male	Steel
12989	1/2 NPTF female x 1/4 NPTF male	Steel
67171	1/2 NPTF female x 3/4 NPTF male	Steel
12287	1/2-27 NPTF female x 1/2 NPTF male	Steel

Pipe Fittings—Nipples

For supply and feed lines.

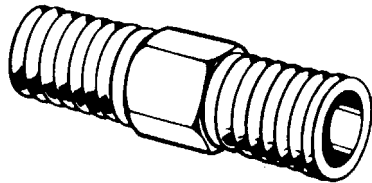

Part No.	Thread / in.	Style	Construction
10130	1/8 NPTF male x 1/8 NPTF male	Hex	Steel
67371	1/8 NPTF male x 1/8 NPTF male	Close	Brass
10772	1/8 NPTF male x 1/4 NPTF male	Hex	Steel
10199	1/8 NPTF male x 1/2-27 male	Hex	Brass
10462	1/4 NPTF male x 1/4 NPTF male	Hex	Steel
10462-9	1/4 NPTF male x 1/4 NPTF male	Hex	Stainless Steel-303
10198	1/4 NPTF male x 1/2-27 male	Hex	Brass
10773	3/8 NPTF male x 1/4 NPTF male	Hex	Steel
14727	3/4 NPTF male x 1/4 NPTF male	Hex	Steel
10540	3/4 NPTF male x 1/4 NPTF male	Hex	Steel
11107	3/8 NPTF male x 3/4 NPTF male	Hex	Steel
11197	1/2 NPTF male x 1/2 NPTF male	Hex	Steel
12957	1/2 NPTF male x 1/2-27 male	Hex	Steel
12106	1/2 NPTF male x 3/4 NPTF male	Hex	Steel
10202	1/2-27 male x 1/2-27 male	Hex	Brass

Pipe Fittings—Couplings

For supply and feed lines.

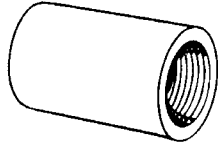

Part No.	Thread / in.	Construction
67063	1/8 NPTF female x 1/8 NPTF female	Steel
67360	1/8 NPTF female x 1/8 NPTF female	Brass
67179	1/2 NPTF female x 1/2 NPTF female	Forged Steel

Pipe Fittings—Reducing Couplings

For supply and feed lines.

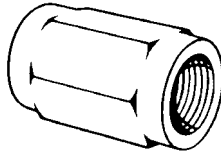

Part No.	Thread / in.	Construction
11852	1/8 NPTF female x 1/2-27 NPTF female	Steel
67094	1/4 NPTF female x 3/8 NPTF female	Malleable Iron
67176	1/4 NPTF female x 1/2 NPTF female	Forged Steel
10522	1/4 NPTF female x 1/2-27 NPTF female	Brass
67296	3/8 NPTF female x 1/2 NPTF female	Forged Steel

Pipe Fittings—Street Ells

For supply and feed lines.

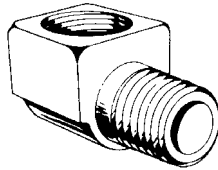

Part No.	Thread / in.	Construction
67368	1/8 NPTF female x 1/8 NPTF male	Brass
67368-9	1/8 NPTF female x 1/8 NPTF male	Stainless Steel-304
67054	1/4 NPTF female x 1/4 NPTF male	Brass
67358	3/8 NPTF female x 3/8 NPTF male	Brass
67074	1/2 NPTF female x 1/2 NPTF male	Malleable Iron
67062	3/4 NPTF female x 3/4 NPTF male	Malleable Iron

Pipe Fittings—Tees

For supply and feed lines.

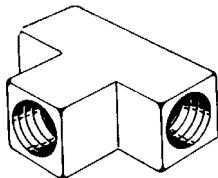

Part No.	Thread / in.	Construction
67011	1/8 NPTF female x 1/8 NPTF female	Brass
67102	1/4 NPTF female x 1/4 NPTF female	Brass
67102-9	1/4 NPTF female x 1/4 NPTF female	Stainless Steel-304
243373	1/2 NPTF female x 1/2 NPTF female	Forged Steel

Street Tee

Part No.	Description
67448	1/8" NPT male x 1/8" NPT female x 1/8" NPT female

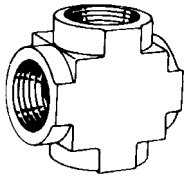

Pipe Fittings—Crosses

For supply and feed lines.

Part No.	Thread / in.	Construction
67362	1/8 NPTF	Brass

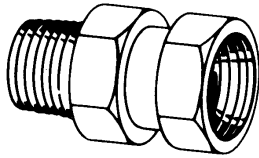

Pipe Fittings—Adapter Unions

For supply and feed lines.

Part No.	Thread / in.	Construction
66649	1/8 NPSM female swivel x 1/8 NPTF male	Steel
66645	1/4 NPSM female swivel x 1/4 NPTF male	Steel
66842	3/8 NPSM female swivel x 3/8 NPTF male	Steel
66883	1/2 NPSM female swivel x 1/2 NPTF male	Steel
69375	1 NPTF female swivel x 1 NPTF male	Steel

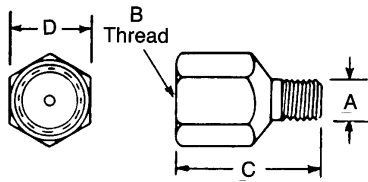

Pipe Fittings—Straight Adapters

For supply and feed lines. Carbon steel.

Part No.	A in.	B in.	C in.	D in.
20024	1/4-28	1/8 NPSF	7/8	1/2
66648	3/16-24	1/8 NPTF	31/32	9/16

Metric

Part No.	A in.	B in.	C in.	D in.
304-19166-1	M6 x 1	1/4-28	.56	.393/.472*
304-19165-1	M8 x 1			
304-19164-1	M10 x 1			

* Hex material may vary

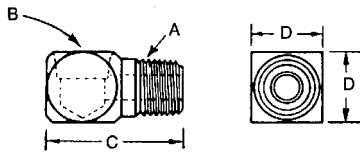

Pipe Fittings—90° Adapters

For supply and feed lines. Carbon Steel.

Part No.	A in.	B in.	C in.	D in.
20026	1/4-28	1/8 *	13/16	1/2
20029	1/8 *	1/8 **	1	1/2
20031	1/8 *	1/8 *	13/16	1/2
20012	1/4 *	1/4 NPTF	1 5/16	1 1/16

* PTF special extra short.

** SAE short.

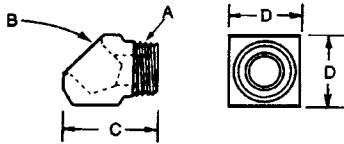

Pipe Fittings—45° Adapters

For supply and feed lines. Carbon Steel.

Part No.	A in.	B in.	C in.	D in.
20028	1/8 **	1/8 **	1	1/2
247616	1/4-28	1/8 *	1 1/16	1/2

* PTF special extra short.

** SAE short.

Supply Line Swivels—Straight Swivels (one swivel section)

For lubricant supply lines. Swivels have steel bodies and nitrile packing.

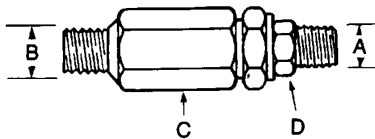

Part No.	A in.	B in.	C in.	D in.	Working Pressure
82080	1/2-27	1/2-27	7/8	9/16	5000 psig / 340 bar
83938	1/4 NPTF	1/4 NPTF	7/8	9/16	
81728	3/8 NPTF	1/2 NPTF	1 1/4	1 1/16	
82072	1/2 NPTF	1/2 NPTF	1 1/4	7/8	

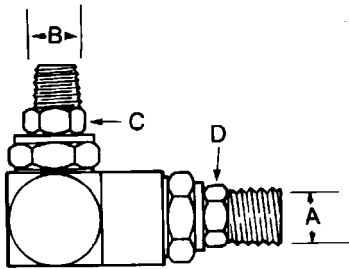

Supply Line Swivels—90° Angle Swivels (one swivel section)

For lubricant supply lines. Swivels have steel bodies and nitrile packing.

Part No.	A in.	B in.	C in.	D in.	Working Pressure
81386	1/8 NPTF	1/2-27	9/16	7/16	5000 psig 340 bar
81723	1/8 NPTF	1/8 NPTF	5/8	7/16	
81974	1/2-27	1/4 NPTF	9/16	9/16	
82251	1/8 NPTF	1/8 NPTF	7/16	7/16	
82087	1/2 NPTF	1/2 NPTF	7/8	7/8	

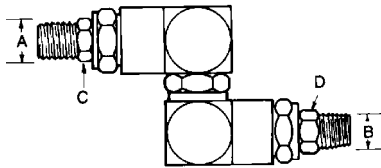

Supply Line Swivels—Universal Swivels (three swivel sections)

For lubricant supply lines. Swivels have steel bodies and nitrile packing.

Part No.	A in.	B in.	C in.	D in.	Working Pressure
82252	1/8 NPTF	1/8 NPTF	7/16	7/16	5000 psig 340 bar
83594	1/4 NPTF	1/4 NPTF	9/16	9/16	
81729	1/2 NPTF	3/8 NPTF	7/8	1 1/16	
82073	1/2 NPTF	1/2 NPTF	7/8	7/8	

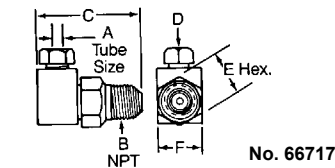

No. 66717

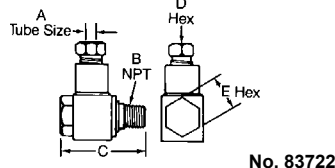

No. 83722

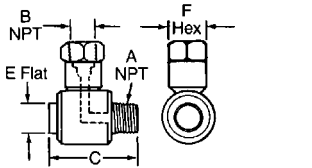

No. 83822

Feed Line Swivels—90° Angle Swivels

For lubricant feed lines. All models have a single swivel section and Buna N seals unless noted otherwise.

Part No.	A Inlet in.	B Outlet in.	C Length in.	D Hex in.	E Hex/Flat in.	F Flat in.
66717	1/8 O.D. Tube	1/8 NPTF (M)	1 1/4	5/16	9/16	1/2
* 66717-9				N/A		
91048	1/8 NPTF (F)	1/4 -28	1 5/16	1 5/16	3/8	
* 91048-9						
* 83722	1/8 O.D. Tube	1/4 -28	1 5/16	1 5/16	3/8	
83822	1/8 NPTF (M)	1/8 NPTF (F)	1 3/8	1/2		

* 303 Stainless Steel

Note: Models 91048 & 91048-9 are similar in appearance to 66717 & 66717-9, but do not include direct tube connections.

Feed Line Swivels—Straight Swivels

For lubricant feed lines. All models have a single swivel section and Buna N seals unless noted otherwise.

Part No.	A Thread in.	B Thread in.	C Length in.	D Hex in.	E Flat in.
91308	1/8 NPTF (F)	1/8 NPTF (M)	1 3/8	9/16	
* 92131			1 1/2	3/4	15/32
* 81606					

* With fluoroelastomer seals.

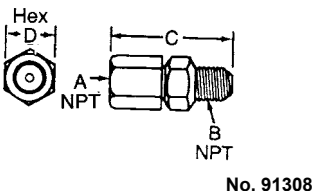

No. 91308

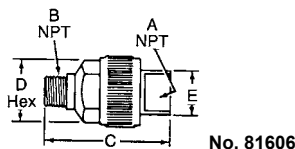

No. 81606

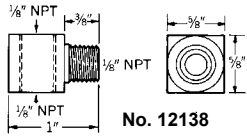

No. 12138

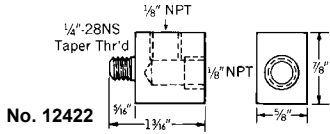

No. 12422

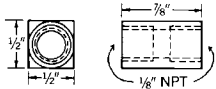

No. 12612

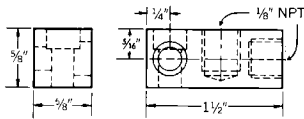

No. 81583

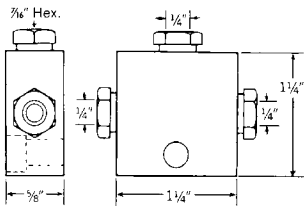

No. 82225

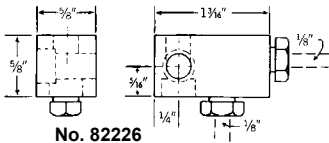

No. 82226

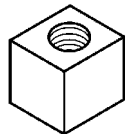

No. 270928



No. 249851



No. 249850

Anchor and Junction Blocks

Securely fasten flexible supply and feed lines.

Part No.	Description	Use with Series Injectors*	Installation Method
12138	Anchor Block	SL-1, 11, 32, 33, 41, 42, 43, 44	Use 1 $\frac{1}{2}$ " drill and 1/8" NPT tap
12422		SL-1, 11, 32, 33, 41, 42, 43, 44	Use No. 3 drill and 1/4" -28 tap
** 81583		SL-1, 11, 32, 33, 41, 42, 43, 44	Use No. 7 drill and 1/4" -20 tap
** 82226		SL-32, 33, 42, 43	Use No. 7 drill and 1/4" -20 tap
** 82225	Junction Block	SL-32, 33, 42, 43	Use No. 7 drill and 1/4" -20 tap

* Can also be used with corresponding size supply and feed lines on Modular Lube II and Quicklub systems.

** Includes 50521 mounting screw.

Stand Offs for Mounting SSV Valves, P-Clamps and Angle Iron

Part No.	Description
252807	Valve mounting block for welding
249987	6 mm bolt to be used with the 252807
249850	12 mm round stand off
270928	12 mm square stand off
249848	12 mm x 5/8" long bolt to be used with 249850 and 270928
249851	10 mm round stand off
249849	10 mm x 5/8" long bolt to be used with 249851