

Steel Tubing

For supply and feedlines.

| Part No. | Size (O.D. x Wall) | | | Working Pressure | Type |
|----------|--------------------|----------|----------------|---------------------|------|
| | O.D. in. | Wall in. | Length ft. / m | | |
| 62175 | 1/8 | .020 | 25 / 7.6 | 4400 psig / 300 bar | coil |
| 62176 | 1/4 | .028 | 25 / 7.6 | 2800 psig / 190 bar | coil |
| 62249 | 3/8 | .028 | 25 / 7.6 | 1850 psig / 126 bar | coil |

Type 304 Stainless Steel Tubing

For supply and feedlines. For corrosive environments. ASTM A-269 specs.

| Part No. | Size (O.D. x Wall) | | | Working Pressure | Type |
|----------|--------------------|----------|----------------|---------------------|------|
| | O.D. in. | Wall in. | Length ft. / m | | |
| 62948-9 | 1/8 | .028 | 20/ 6.1 | 9000 psig / 612 bar | coil |
| 62949-9 | 1/4 | .028 | 20/ 6.1 | 4480 psig / 305 bar | coil |
| 62950-9 | 3/8 | .028 | 20/ 6.1 | 2980 psig / 203 bar | coil |

Nylon Tubing

For feedlines. Temperature range -65°F to 150°F.

| Part No. | Size (O.D. x Wall) | | | Working Pressure | Minimum Bend Radius in. |
|----------|--------------------|----------|----------------|----------------------|-------------------------|
| | O.D. in. | Wall in. | Length ft. / m | | |
| 62256 | 1/8 | .026 | 25 / 7.6 | 625 psig 42.5 bar | .375 |
| 62278 | | | 100 / 30.5 | | |
| 62956 | | | 500 / 152 | | |
| 62357 | 1/4 | .050 | 100 / 30.5 | | .875 |
| 247022 | | | 500 / 152 | | |

Single and Multiple Tube Clamps

For feedlines.

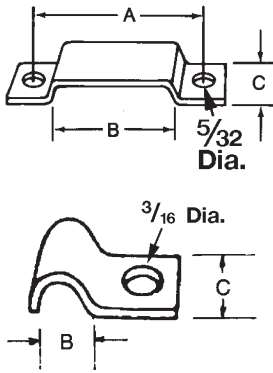

| Clamp No. | Const. | No. Tubes | Tube Size in. | A in. | B in. | C in. | Screw No. | Screw Descrip. | |
|-----------|--------------------------|-----------|---------------|--------|----------|-------|-----------|---|-----|
| 64532-1 | Steel | 1 | 1/8 OD | — | 1/8 | 1/2 | 66202 | No. 6 roundhead 1/4" LG, Use No. 30 drill | |
| 64532-2 | | 2 | | 1 1/16 | 1/4 | 3/8 | | | |
| 64532-3 | | 3 | | 1 3/16 | 3/8 | 3/8 | | | |
| 64532-4 | | 4 | | 1 5/16 | 1/2 | 3/8 | | | |
| 64532-5 | | 5 | | 1 1/16 | 5/8 | 3/8 | | | |
| 64533-1 | | 1 | 2 | 1/4 OD | — | 1/4 | | | 1/2 |
| 64533-2 | | | | | 1 5/16 | 1/2 | | | 3/8 |
| 64533-3 | | | | | 1 3/16 | 3/4 | | | 3/8 |
| 64533-4 | | | | | 1 7/16 | 1 | | | 3/8 |
| 64533-5 | | | | | 1 1 1/16 | 1 1/4 | | | 3/8 |
| 69159-9 | Type 303 Stainless Steel | 1 | 1/8 OD | — | 1/8 | 3/8 | 66202-9 | | |
| 69160-9 | | 2 | | 1 1/16 | 1/4 | 3/8 | | | |
| 69161-9 | | 3 | | 1 3/16 | 3/8 | 3/8 | | | |
| 69163-9 | | 5 | | 1 1/16 | 5/8 | 3/8 | | | |

Single Tube Clamps

For supply lines.

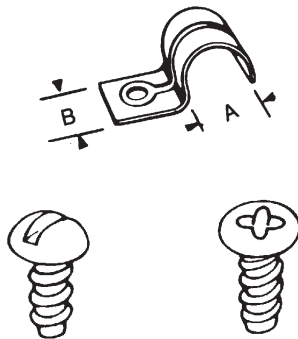

| Clamp No. | Const. | Tube Size in. | A in. | B in. | Screw No. | Screw Description |
|-----------|--------------------------|---------------|-------|-------|-----------|---|
| 360108 | Steel | 3/8 OD | 3/8 | 1/2 | 66872 | No. 10 round head, self-tapping 1/4" LG, use No. 17 drill |
| 69164-9 | Type 303 Stainless Steel | 1/4 OD | 1/4 | 3/8 | 66202-9 | No. 6 round head, self-tapping 1/4" LG, use No. 30 drill |
| 69165-9 | | 3/8 OD | 3/8 | 1/2 | 66872-9 | No. 10 round head, self-tapping 1/4" LG, use No. 17 drill |

Note: Screws listed in above tables. Order separately.

P Clamps

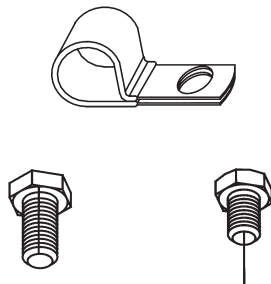

| Clamp No. | Description | Material | Width in. | Length in. | Screw Description |
|-----------|-----------------------|----------|-----------|------------|----------------------------|
| 249853 | 1 3/16" P style clamp | CRS | 1 | 2 7/32 | Use 249848 or 249849 bolts |
| 249913 | 3/8" P style clamp | CRS | 1 | | |
| 270931 | 3/4" P style clamp | CRS | 1 | 2 3/16 | |

Spring Coil

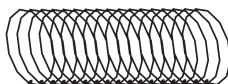

| Clamp No. | Description | Material | Width in. | Screw Description |
|-----------|-----------------|----------|-----------|----------------------------|
| 272598 | 25' spring coil | Steel | 5/8" ID | Use 249848 or 249849 bolts |

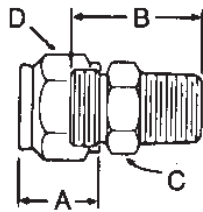

Heavy-Duty Tube Fittings—Male Connector

Tube to male pipe thread. For supply lines. Carbon steel unless noted (*) otherwise.

| Part No. | Tube O.D. in. | Pipe Thread in. | A in. | B in. | Hex. C in. | Hex. D in. | Working Press. psig / bar |
|----------|---------------|-----------------|-------|---------|------------|------------|---------------------------|
| 69068 | 1/4 | 1/8 NPT | 19/32 | 61/64 | 1/2 | 5/8 | 5000 / 340 |
| *69068-9 | 1/4 | 1/8 NPT | 19/32 | 61/64 | 1/2 | 5/8 | 5000 / 340 |
| 69069 | 1/4 | 1/4 NPT | 19/32 | 15/32 | 5/8 | 5/8 | 5000 / 340 |
| *69069-9 | 1/4 | 1/4 NPT | 19/32 | 15/32 | 5/8 | 5/8 | 5000 / 340 |
| 69070 | 3/8 | 1/8 NPT | 3/4 | 1 | 5/8 | 3/4 | 5000 / 340 |
| 69071 | 3/8 | 1/4 NPT | 3/4 | 1 13/64 | 5/8 | 3/4 | 5000 / 340 |
| 69072 | 3/8 | 3/8 NPT | 3/4 | 1 13/64 | 3/4 | 3/4 | 5000 / 340 |

* 316 Stainless Steel

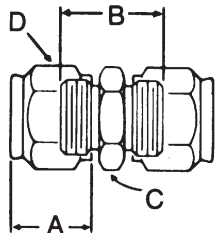

Heavy-Duty Tube Fittings—Union Connector

Tube to tube. For supply lines. Carbon steel unless noted (*) otherwise.

| Part No. | Tube O.D. in. | A in. | B in. | Hex. C in. | Hex. D in. | Working Press. psig / bar |
|----------|---------------|-------|--------|------------|------------|---------------------------|
| 69078 | 3/8 | 3/4 | 1 1/16 | 5/8 | 3/4 | 6000 / 400 |

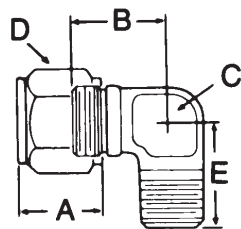

Heavy-Duty Tube Fittings—Male Elbow

Tube to male pipe thread. For supply lines. Carbon steel unless noted (*) otherwise.

| Part No. | Tube O.D. in. | Pipe Thd. in. | A in. | B in. | Flats C in. | Hex. D in. | E in. | Working Press. psig / bar |
|----------|---------------|---------------|-------|-------|-------------|------------|-------|---------------------------|
| *69079-9 | 1/4 | 1/8 NPT | 19/32 | 3/4 | 7/16 | 5/8 | 25/32 | 5000 / 340 |
| 69082 | 3/8 | 1/4 NPT | 3/4 | 59/64 | 9/16 | 3/4 | 13/32 | 5000 / 340 |
| *69082-9 | 3/8 | 1/4 NPT | 3/4 | 59/64 | 9/16 | 3/4 | 13/32 | 5000 / 340 |
| 69083 | 3/8 | 3/8 NPT | 3/4 | 17/64 | 3/4 | 3/4 | 17/32 | 5000 / 340 |

* 316 Stainless Steel

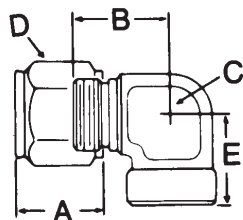

Heavy-Duty Tube Fittings—Female Elbow

Tube to female pipe thread. For supply lines. Carbon steel unless noted (*) otherwise.

| Part No. | Tube O.D. in. | Pipe Thd. in. | A in. | B in. | Flats C in. | Hex. D in. | E in. | Working Press. psig / bar |
|----------|---------------|---------------|-------|-------|-------------|------------|-------|---------------------------|
| 69084 | 1/4 | 1/8 NPT | 19/32 | 25/32 | 1/2 | 5/8 | 11/16 | 5000 / 340 |
| *69085 | 1/4 | 1/4 NPT | 19/32 | 1 | 3/4 | 5/8 | 7/8 | 5000 / 340 |

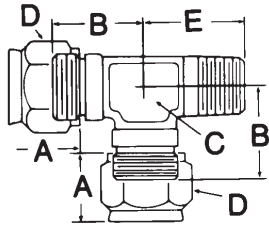

Heavy-Duty Tube Fittings—Male Run Tee

Tube to male pipe thread to tube. For supply lines. Carbon steel unless noted (*) otherwise.

| Part No. | Tube O.D. in. | Pipe Thd. in. | A in. | B in. | Flats C in. | Hex. D in. | E in. | Working Press. psig / bar |
|----------|---------------|---------------|-------|-------|-------------|------------|-------|---------------------------|
| 69089 | 1/4 | 1/4 NPT | 19/32 | 25/32 | 1/2 | 5/8 | 15/16 | 5000 / 340 |

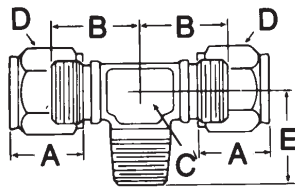

Heavy-Duty Tube Fittings—Male Branch Tee

Tube to tube to male pipe thread. For supply lines. Carbon steel unless noted (*) otherwise.

| Part No. | Tube O.D. in. | Pipe Thd. in. | A in. | B in. | Flats C in. | Hex. D in. | E in. | Working Press. psig / bar |
|----------|---------------|---------------|-------|-------|-------------|------------|--------|---------------------------|
| 69093 | 3/8 | 1/4 NPT | 3/4 | 63/64 | 5/8 | 3/4 | 1 1/16 | 5000 / 340 |

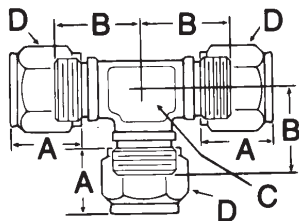

Heavy-Duty Tube Fittings—Union Tee

Tube to tube to tube. For supply lines. Carbon steel unless noted (*) otherwise.

| Part No. | Tube O.D. in. | A in. | B in. | Flats C in. | Hex. D in. | Working Press. psig / bar |
|----------|---------------|-------|-------|-------------|------------|---------------------------|
| 69094 | 1/4 | 19/32 | 3/4 | 7/16 | 5/8 | 5000 / 340 |
| 69095 | 3/8 | 3/4 | 63/64 | 5/8 | 3/4 | 5000 / 340 |

* 316 Stainless Steel

Heavy-Duty Tube Fittings—Sleeve

For supply lines. Carbon steel unless noted (*) otherwise.



| Part No. | Tube O.D. in. |
|----------|---------------|
| 69098 | 1/4 |
| 69099 | 3/8 |

* 316 Stainless Steel

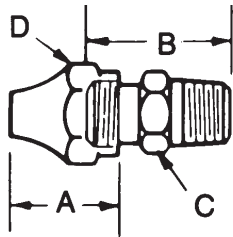

Standard-Duty Tube Fittings—Male Connector

Tube to male pipe thread. For supply and feed lines. Brass unless noted (*) otherwise.

| Part No. | Tube O.D. in. | Pipe Thd. in. | A in. | B in. | Hex. C in. | Hex. D in. | Working Pressure psig / bar |
|----------|---------------|---------------|-------|--------|------------|------------|-----------------------------|
| 66200 | 1/4 | 1/8 NPT | 3/4 | 7/8 | 7/16 | 9/16 | 2000 / 136 |
| 66211 | 1/4 | 1/4 NPT | 3/4 | 1 1/16 | 9/16 | 9/16 | 2000 / 136 |
| 68415 | 3/8 | 1/8 NPT | 7/8 | 31/32 | 9/16 | 1 1/16 | 2000 / 136 |
| 66846 | 3/8 | 1/4 NPT | 7/8 | 1 5/32 | 9/16 | 1 1/16 | 2000 / 136 |
| *69169-9 | 1/8 | 1/8 NPT | 33/64 | 27/32 | 7/16 | 1/2 | 2000 / 136 |

* 316 Stainless Steel

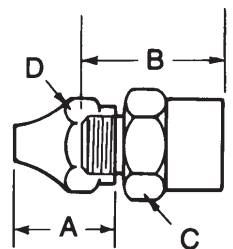

Standard-Duty Tube Fittings—Female Connector

Tube to female pipe thread. For supply and feed lines. Brass unless noted (*) otherwise.

| Part No. | Tube O.D. in. | Pipe Thd. in. | A in. | B in. | Hex. C in. | Hex. D in. | Working Pressure psig / bar |
|----------|---------------|---------------|-------|-------|------------|------------|-----------------------------|
| 68943 | 1/4 | 1/8 NPT | 3/4 | 25/32 | 9/16 | 9/16 | 2000 / 136 |

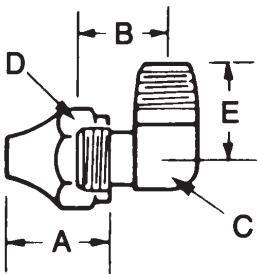

Standard-Duty Tube Fittings—Male Elbow

Tube to male pipe thread. For supply and feed lines. Brass unless noted (*) otherwise.

| Part No. | Tube O.D. in. | Pipe Thd. in. | A in. | B in. | Flats C in. | Hex. D in. | E in. | Working Press. psig / bar |
|----------|---------------|---------------|-------|--------|-------------|------------|--------|---------------------------|
| 66201 | 1/4 | 1/8 NPT | 3/4 | 19/32 | 7/16 | 9/16 | 23/32 | 2000 / 136 |
| 66210 | 1/4 | 1/4 NPT | 3/4 | 5/8 | 9/16 | 9/16 | 3/4 | 2000 / 136 |
| 68412 | 3/8 | 1/8 NPT | 7/8 | 1 1/16 | 9/16 | 1 1/16 | 1 1/16 | 2000 / 136 |
| 66762 | 3/8 | 1/4 NPT | 7/8 | 23/32 | 9/16 | 1 1/16 | 29/32 | 2000 / 136 |
| 68414 | 3/8 | 3/8 NPT | 7/8 | 27/32 | 1 1/16 | 1 1/16 | 31/32 | 2000 / 136 |
| *69166-9 | 1/8 | 1/8 NPT | 33/64 | 21/32 | 7/16 | 1/2 | 3/4 | 2000 / 136 |

* 316 Stainless Steel

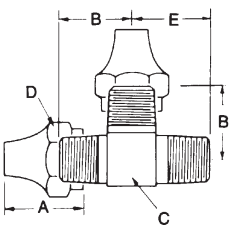

Standard-Duty Tube Fittings—Male Run Tee

For supply and feed lines. Brass unless noted (*) otherwise. Tube to male pipe thread to tube.

| Part No. | Tube O.D. in. | Pipe Thd. in. | A in. | B in. | Flats C in. | Hex. D in. | E in. | Working Press. psig / bar |
|----------|---------------|---------------|-------|-------|-------------|------------|-------|---------------------------|
| 68615 | 1/4 | 1/8 NPTF | 3/4 | 21/32 | 7/16 | 9/16 | 23/32 | 2000 / 136 |

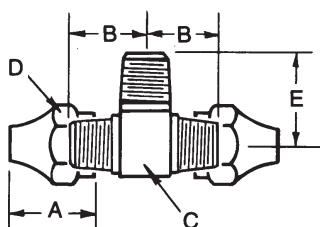

Standard-Duty Tube Fittings—Male Branch Tee

Tube to tube to male pipe thread. For supply and feed lines. Brass unless noted (*) otherwise.

| Part No. | Tube O.D. in. | Pipe Thd. in. | A in. | B in. | Flats C in. | Hex. D in. | E in. | Working Press. psig / bar |
|----------|---------------|---------------|-------|-------|-------------|------------|-------|---------------------------|
| 66651 | 1/4 | 1/8 NPTF | 3/4 | 21/32 | 7/16 | 9/16 | 23/32 | 2000 / 136 |
| 66876 | 3/8 | 1/4 NPTF | 7/8 | 25/32 | 9/16 | 1 1/16 | 29/32 | 2000 / 136 |

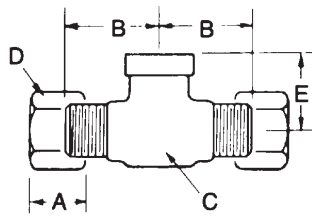

Standard-Duty Tube Fittings—Female Branch Tee

Tube to tube to female pipe thread. For supply and feed lines. Brass unless noted (*) otherwise.

| Part No. | Tube O.D. in. | Pipe Thd. in. | A in. | B in. | Flats C in. | Hex. D in. | E in. | Working Press. psig / bar |
|----------|---------------|---------------|-------|--------|-------------|------------|-------|---------------------------|
| 67374 | 3/8 | 1/4 NPTF | 3/4 | 1 1/16 | 3/4 | 1 1/16 | 7/8 | 2000 / 136 |

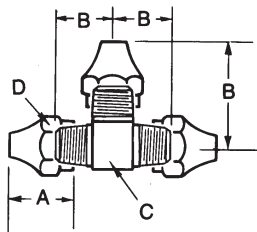

Standard-Duty Tube Fittings—Union Tee

Tube to tube to tube. For supply and feed lines. Brass unless noted (*) otherwise.

| Part No. | Tube O.D. in. | A in. | B in. | C in. | Hex. D in. | Working Press. psig / bar |
|----------|---------------|-------|-------|-------|------------|---------------------------|
| 66650 | 1/4 | 3/4 | 5/8 | 7/16 | 9/16 | 2000 / 136 |
| 66878 | 3/8 | 7/8 | 23/32 | 9/16 | 1 1/16 | 2000 / 136 |

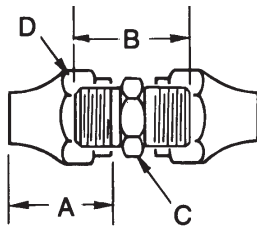

Standard-Duty Tube Fittings—Union

Tube to tube. For supply and feed lines. Brass unless noted (*) otherwise.

| Part No. | Tube O.D. in. | A in. | B in. | Hex C in. | Hex. D in. | Working Press. psig / bar |
|----------|---------------|-------|-------|-----------|------------|---------------------------|
| 68468 | 1/4 | 3/4 | 25/32 | 7/16 | 9/16 | 2000 / 136 |



Standard-Duty Tube Fittings—Sleeve

For supply and feed lines. Brass unless noted (*) otherwise. Included with all standard duty fittings.

| Part No. | Tube O.D. - in. |
|----------|-----------------|
| 68462 | 1/4 |
| 68463 | 3/8 |
| *69170-9 | 1/8 |

* 316 Stainless Steel

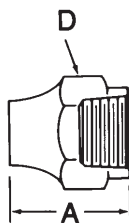

Standard-Duty Tube Fittings—Nut

For supply and feed lines. Carbon steel unless noted (*) otherwise. Included with all standard duty fittings.

| Part No. | Tube O.D. in. | A in. | Hex. D in. |
|----------|---------------|-------|------------|
| 68464 | 1/4 | 3/4 | 9/16 |
| *69171-9 | 1/8 | 33/64 | 1/2 |

* 316 Stainless Steel

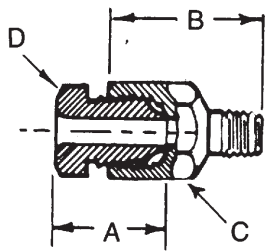

Threaded Sleeve Tube Fittings—Straight

Tube to male thread. For feed lines. Carbon steel with brass nut unless noted (*) otherwise.

| Part No. | Tube O.D. in. | Thread in. | A in. | B in. | Hex C in. | Hex. D in. | Working Press. psig / bar |
|----------|---------------|------------|-------|--------|-----------|------------|---------------------------|
| 66771 | 1/8 | 10-32 | 1/2 | 1 1/16 | 3/8 | 5/16 | 500 / 34 |
| 66714 | 1/8 | 1/4 -28 | 1/2 | 5/8 | 3/8 | 5/16 | 500 / 34 |
| *66714-9 | 1/8 | 1/4 -28 | 1/2 | 5/8 | 3/8 | 5/16 | 500 / 34 |
| 66772 | 1/8 | 1/4 -28 | 1/2 | 1 1/16 | 3/8 | 5/16 | 500 / 34 |
| 66730 | 1/8 | 5/16 -32 | 1/2 | 1 1/16 | 3/8 | 5/16 | 500 / 34 |
| 66773 | 1/8 | 3/8 -24 | 1/2 | 1 1/16 | 7/16 | 5/16 | 500 / 34 |
| 66415 | 1/8 | 1/8 NPTF | 1/2 | 5/8 | 7/16 | 5/16 | 500 / 34 |

* 303 Stainless Steel

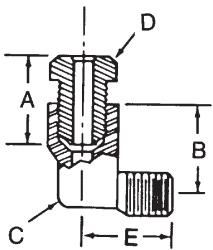

Threaded Sleeve Tube Fittings—90° Elbow

Tube to male thread. For feed lines. Brass with brass nut unless noted (*) otherwise.

| Part No. | Tube O.D. in. | Thread in. | A in. | B in. | Flats C in. | Hex. D in. | E in. | Working Press. psig / bar |
|----------|---------------|------------|-------|-------|-------------|------------|--------|---------------------------|
| 66716 | 1/8 | 1/4 -28 | 1/2 | 1/2 | 1 3/32 | 5/16 | 33/64 | 500 / 34 |
| 66414 | 1/8 | 1/8 NPTF | 1/2 | 1/2 | 7/16 | 5/16 | 2 1/32 | 500 / 34 |

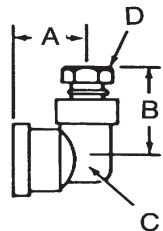

Threaded Sleeve Tube Fittings—90° Elbow

Tube to female pipe thread. For feed lines. Brass with brass nut unless noted (*) otherwise.

| Part No. | Tube O.D. in. | Pipe Thd. in. | A in. | B in. | Flats C in. | Hex. D in. | Working Press. psig / bar |
|----------|---------------|---------------|-------|--------|-------------|------------|---------------------------|
| 66935 | 1/8 | 1/8 NPT | 23/32 | 1 1/32 | 3/8 | 5/16 | 500 / 34 |

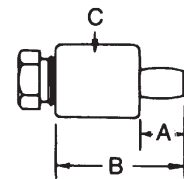

Threaded Sleeve Tube Fittings—Drive-Type

For feed lines. Steel body with brass nut.

| Part No. | Hole Size in. | Tube O.D. in. | A in. | B in. | Dia. C in. | Hex. D in. | Working Press. psig / bar |
|----------|---------------|---------------|-------|-------|------------|------------|---------------------------|
| 82092 | 3/16 | 1/8 | 13/64 | 45/64 | 7/16 | 5/16 | 500 / 34 |

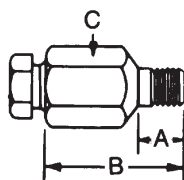

Threaded Sleeve Tube Fittings—Spin-Drive Type

For feed lines. Steel body with brass nut.

| Part No. | Hole Size in. | Tube O.D. in. | A in. | B in. | Hex C in. | Hex. D in. | Working Press. psig / bar |
|----------|---------------|---------------|-------|-------|-----------|------------|---------------------------|
| 82093 | 1/4 | 1/8 | 5/32 | 5/8 | 7/16 | 5/16 | 500 / 34 |

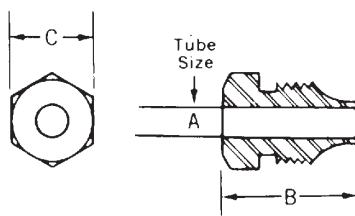

Threaded Sleeve Tube Fittings—Compression Nuts

For feed lines. Brass unless noted (*) otherwise.

| Part No. | A Tube Size O.D. in. | B in. | C in. | Working Press. psig / bar |
|----------|----------------------|-------|-------|---------------------------|
| 66260 | 1/8 | 1/2 | 5/16 | 500 / 34 |
| *66260-9 | 1/8 | 1/2 | 5/16 | 500 / 34 |
| 66713 | 1/4 | 5/8 | 7/16 | 500 / 34 |

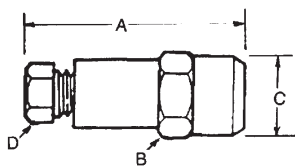

Snap-on Coupler Tube Fittings—Straight

Connect tubing to existing hydraulic (grease) fittings. Aluminum body, brass nut, Buna N packing.

| Part No. | Tube O.D. Size in. | A in. | B Hex in. | C in. | D Hex in. | Working Press. psig / bar |
|----------|--------------------|-------|-----------|-------|-----------|---------------------------|
| *82617 | 1/8 | 1.18 | 7/16 | .43 | 1/4 | 500 psi 34 bar |
| **241389 | 1/4 | 1.69 | 5/8 | .43 | 7/16 | |

* Uses Model 13112 compression nut (included). **Uses 66713 compression nut (included).

Note: Coupling to grease fitting is a permanent connection.

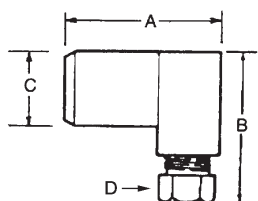

Snap-on Coupler Tube Fittings—90° Elbow

Connect tubing to existing hydraulic (grease) fittings. Aluminum body, brass nut, Buna N packing.

| Part No. | Tube O.D. Size in. | A in. | B Hex in. | C in. | D Hex in. | Working Press. psig / bar |
|----------|--------------------|-------|-----------|-------|-----------|---------------------------|
| *82618 | 1/8 | .83 | .86 | .43 | 1/4 | 500 psi 34 bar |
| **241388 | 1/4 | 1.03 | 1.18 | .43 | 7/16 | |

* Uses Model 13112 compression nut (included). **Uses 66713 compression nut (included).

Note: Coupling to grease fitting is a permanent connection.

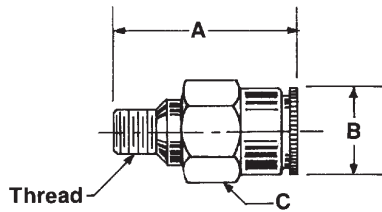

Quicklinc™ Tubing Adapter – Male Straight

Use with 1/4" O.D. non-metallic tube for quick installation. Tubing simply pushes into place without ferrules or flairs. Nickel plated brass construction.

| Part No. | Tube O.D. Size - in. | Thread | Dimensions - in. / mm | | | Max. Oper. Pressure |
|----------|----------------------|-----------------|-----------------------|-------------|-----------|---------------------|
| | | | A | B | C-Hex | |
| 244047 | 1/4 | 1/8" NPTF | .984 / 25 | .460 / 11.7 | .472 / 12 | 250 psig / 17 bar |
| 244055 | | 1/4-28 | .784 / 19.9 | | | |
| 244057 | | M6X1-6G Tapered | .965 / 24.5 | | | |

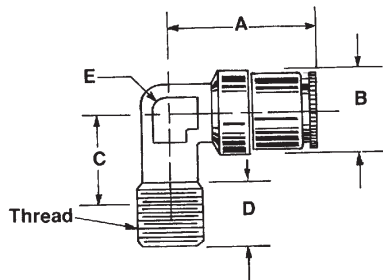

Quicklinc™ Tubing Adapter – Male 90° Elbow, Non-Swivel

Use with 1/4" O.D. non-metallic tube for quick installation. Tubing simply pushes into place without ferrules or flairs. Nickel plated brass construction.

| Part No. | Tube O.D. Size - in. | Thread | Dimensions - in. / mm | | | | | Max. Oper. Pressure |
|----------|----------------------|-----------------|-----------------------|--------------|------------|------------|------------|---------------------|
| | | | A | B | C | D | E-Flat | |
| 244048 | 1/4 | 1/8" NPTF | .905 23 | .500 12.7 | .531 | .374 / 9.5 | .394 10 | 250 psig 17 bar |
| 244054 | | 1/4-28 | | | 13.5 | .172 / 4.4 | | |
| 244056 | | M6X1-6G Tapered | | | .590 15 | 200 / 5 | | |

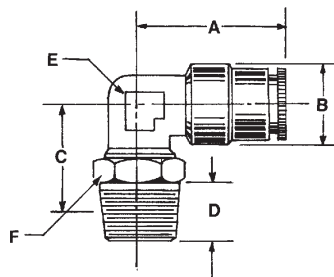

Quicklinc™ Tubing Adapter – Male 90° Elbow, Swivel

Use with 1/4" O.D. non-metallic tube for quick installation. Tubing simply pushes into place without ferrules or flairs. Nickel plated brass construction.

| Part No. | Tube O.D. Size - in. | Thread | Dimensions - in. / mm | | | | | | Max. Oper. Pressure |
|----------|----------------------|-----------|-----------------------|------|------|------|--------|-------|---------------------|
| | | | A | B | C | D | E-Flat | F-Hex | |
| 243699 | 1/4 | 1/8" NPTF | .905 | .500 | .728 | .374 | .354 | .472 | 250 psig 17 bar |
| 244053 | | 1/4 - 28 | 23 | 12.7 | 18.5 | 9.5 | 9 | 12 | |

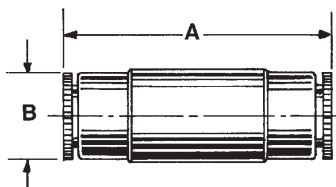

Quicklinc™ Tubing Adapter – Tube Union

Use with 1/4" O.D. non-metallic tube for quick installation. Tubing simply pushes into place without ferrules or flairs. Nickel plated brass construction.

| Part No. | Tube O.D. Size - in. | Dimensions - in. / mm | | Max. Oper. Pressure |
|----------|----------------------|-----------------------|-------------|---------------------|
| | | A | B | |
| 244058 | 1/4 | 1.397 / 35.5 | .460 / 11.7 | 250 psig / 17 bar |

Supply Line and Material Hose

| Type | I.D. in. | Wire Braid | Working Pressure | Min. Burst Pressure | Fittings in. | Min. Bend Radius in. | Part No. | Length | |
|----------------------------|----------|------------|----------------------|------------------------|-----------------|----------------------|----------|--------|-------|
| | | | | | | | | in. | cm |
| 75 High Pressure | ¼ | Double | 5000 psig 340 bar | 20000 psig 1360 bar | ½ -27 female | 4 | 75024 | 24 | |
| | | | | | | | 75060 | 60 | |
| | | | | | | | 75084 | 84 | |
| | | | | | | | 75120 | 120 | |
| | | | | | | | 75168 | 168 | |
| | | | | | | | 75240 | 240 | |
| | | | | | | | 75360 | 360 | |
| | | | | | | | 75480 | 480 | |
| 759 High Pressure | ¾ | Double | 4500 psig 306 bar | 20000 psig 1360 bar | ⅛ NPT male | 2½ | 75948 | 48 | 122 |
| | | | | | | | 75960 | 60 | 152 |
| 76B High Pressure | ¾ | Double | 4000 psig 272 bar | 16000 psig 1088 bar | ½ NPT female | 5 | 76024B | 24 | 61 |
| | | | | | | | 76600B | 600 | 1525 |
| | | | | | | | 76900B | 900 | 2288 |
| 76A High Pressure | ½ | Double | 3500 psig 238 bar | 14000 psig 952 bar | ½ NPT female | 7 | 76024A | 24 | 61 |
| | | | | | | | 76600A | 600 | 1525 |
| 79 Volume Med. Pressure | ¾ | Single | 2250 psig 153 bar | 9000 psig 612 bar | ¾ NPT male | 5 | 79060 | 60 | 152.4 |
| 73 Med. Pressure | ½ | Single | 1000 psig 68 bar | 4000 psig 68 bar | ½ NPT male | | 73024 | 24 | 61 |
| | | | | | | | 73036 | 36 | 91.4 |
| | | | | | | | 73060 | 60 | 152.4 |
| | | | | | | | 73120 | 120 | 305 |
| | | | | | | | 73240 | 240 | 610 |
| | | | | | | | 73360 | 360 | 915 |
| | | | | | | | 73480 | 480 | 1220 |
| | | | | | | | 73600 | 600 | 1525 |
| 73900 | 900 | 2288 | | | | | | | |
| 78 Med. Pressure | ⅝ | Single | 1500 psig 102 bar | 6000 psig 408 bar | ½ NPT male | | 78600 | 600 | 1525 |
| 1230 Med. Pressure | ¾ | Double | 2250 psig 153 bar | 9000 psig 612 bar | ¾ NPT male | | 1230120 | 120 | 305 |

Note: Refer to Design Guides for the correct hose for your system.

Feed Line Hose (SAE 30R-3 Type)

For flexible connections between lube outlets, anchor blocks, swivels, tube connectors and bearings. Hose is $\frac{3}{16}$ " I.D. x $\frac{3}{8}$ " O.D.

Series 71900

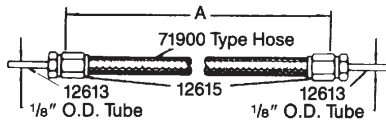

| Part No. | Connections in. | Working Pressure | Min. Bend Radius in. | Length "A" | |
|----------|-------------------------------------|--------------------|----------------------|------------|------|
| | | | | in. | cm |
| 71908 | 1/8 O.D. tube x 1/8 O.D. tube | 500 psig 34 bar | 2 | 8 | 20.3 |
| 71912 | | | | 12 | 30.5 |
| 71918 | | | | 18 | 45.7 |

Series 82238

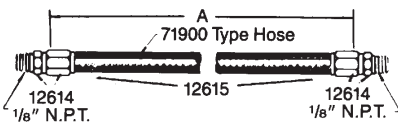

| Part No. | Connections in. | Working Pressure | Min. Bend Radius in. | Length "A" | |
|----------|---------------------------------|--------------------|----------------------|------------|------|
| | | | | in. | cm |
| 82238-12 | 1/8 NPTF(M) x 1/8 NPTF(M) | 500 psig 34 bar | 2 | 12 | 30.5 |
| 82238-18 | | | | 18 | 45.7 |
| 82238-24 | | | | 24 | 61 |

Series 81712

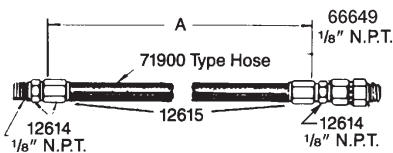

| Part No. | Connections in. | Working Pressure | Min. Bend Radius in. | Length "A" | |
|----------|--|--------------------|----------------------|------------|------|
| | | | | in. | cm |
| 81712-6 | 1/8 NPTF(M) x #66649 Adapter Union 1/8 NPTF(M) | 500 psig 34 bar | 2 | 6 | 15.2 |
| 81712-8 | | | | 8 | 20.3 |
| 81712-18 | | | | 18 | 45.7 |
| 81712-24 | | | | 24 | 61 |
| 81712-30 | | | | 30 | 76.2 |
| 81712-36 | | | | 36 | 91.4 |

Series 82239

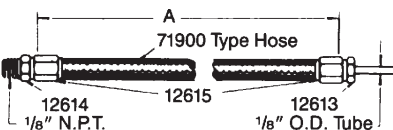

| Part No. | Connections in. | Working Pressure | Min. Bend Radius in. | Length "A" | |
|----------|-----------------------------------|--------------------|----------------------|------------|------|
| | | | | in. | cm |
| 82239-12 | 1/8 O.D. tube x 1/8 NPTF(M) | 500 psig 34 bar | 2 | 12 | 30.5 |
| 82239-18 | | | | 18 | 45.7 |
| 82239-24 | | | | 24 | 61 |

Bulk Feed Line Hose and Fittings

Cut to required length and install connector fittings with standard wrenches. SAE 30R3 type hose. Temperature range -40°F to 212°F.

Bulk Type 71900 Hose

| Part No. | Size | | Working Pressure | Min. Bend Radius in. | Length ft. / m |
|----------|------------|------------|-------------------|----------------------|----------------|
| | I.D. - in. | O.D. - in. | | | |
| 66844 | 3/16 | 3/8 | 500 psig / 34 bar | 2 | 25 / 7.6 |
| 71900 | | | | | Specify length |

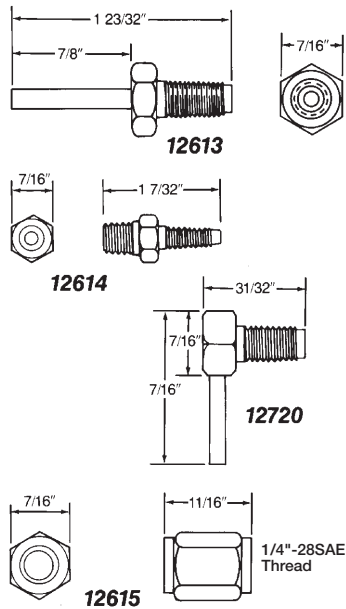

Fittings for 71900 Hose

| Part No. | Construction | Description | Size - in. |
|----------|--------------------------|--------------|--|
| 12613 | Steel | Hose Stud | 1/8 O.D. tube x 1/4-28 male |
| 12614 | | | 1/8 NPT male x 1/4-28 male |
| 13003 | | | 1/4 -28 male x 1/4-28 male |
| 12720 | | | 1/8 O.D. tube x 1/4-28 male, 90° angle |
| 12615* | | Coupling Nut | 1/4-28 female |
| 12613-9 | Type 303 Stainless Steel | Hose Stud | 1/8 O.D. tube x 1/4-28 male |
| 12614-9 | | | 1/8 NPT male x 1/4-28 male |
| 12615-9* | | | Coupling Nut |

* One coupling nut required for each hose stud.

Air Hose

Connect system to compressed air supply.

| Part No. | Length ft. | Specifications | | | Maximum Pressure | | Braid |
|----------|------------|----------------|----------|--------------|--------------------|---------------------|-------------|
| | | I.D. in. | O.D. in. | Thread in. | Working | Burst | |
| 72024 | 2 | 1/4 | 5/8 | 1/4 NPT male | 250 psig 17 bar | 1250 psig 85 bar | 2-Ply Rayon |
| 72036 | 3 | | | | | | |
| 72060 | 5 | | | | | | |
| 72120 | 10 | | | | | | |
| 72240 | 20 | | | | | | |
| 72480 | 40 | | | | | | |
| 72600 | 50 | 3/8 | 23/32 | 3/8 NPT male | 250 psig 17 bar | 1250 psig 85 bar | 2-Ply Rayon |
| 72024A | 2 | | | | | | |
| 72360A | 30 | | | | | | |
| 72480A | 40 | | | | | | |
| 72600A | 50 | | | | | | |
| 72720A | 60 | 1/2 | 23/32 | 1/2 NPT male | 200 psig 14 bar | 800 psig 55 bar | 1-Ply Rayon |
| 74024 | 2 | | | | | | |
| 74060 | 5 | | | | | | |
| 74480 | 40 | | | | | | |
| 74600 | 50 | | | | | | |



Heavy-Duty Air Line Quick Disconnects

Rugged, high flow industrial design steel couplers and nipples.

| For 3/8" I.D. Hose | | | |
|--------------------|-------------|------------|-------------------|
| Part | Description | Size | Max. Air Pressure |
| 645006 | Coupler | 3/8" NPT F | 300 psig / 20 bar |
| For 1/2" I.D. Hose | | | |
| Part | Description | Size | Max. Air Pressure |
| 655008 | Coupler | 1/2" NPT F | 300 psig |
| 655012 | Coupler | 3/4" NPT F | |
| 653112 | Nipple | 3/4" NPT M | 20 bar |
| For 3/4" I.D. Hose | | | |
| Part | Description | Size | Max. Air Pressure |
| 662012 | Coupler | 3/4" NPT F | 300 psig |
| 660112 | Nipple | 3/4" NPT M | 20 bar |

Pipe Fittings—Reducing Bushings

For supply and feed lines.

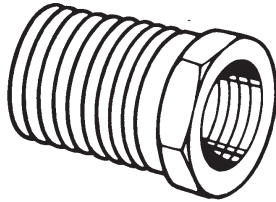

| Part No. | Thread / in. | Construction |
|----------|------------------------------------|--------------|
| 10461 | 1/8 NPTF female x 1/4 NPTF male | Steel |
| 10200 | 1/8 NPTF female x 1/2-27 NPTF male | Brass |
| 11229 | 1/4 NPTF female x 1/8 NPTF male | Steel |
| 11348 | 1/4 NPTF female x 1/4 NPTF male | Steel |
| 20011 | 1/4 NPTF female x 3/8 NPTF male | Steel |
| 12080 | 1/4 NPTF female x 1/2 NPTF male | Steel |
| 10204 | 1/4 NPTF female x 1/2-27 NPTF male | Brass |
| 10049 | 3/8 NPTF female x 1/4 NPTF male | Steel |
| 67069 | 3/8 NPTF female x 1/2 NPTF male | Steel |
| 67198 | 3/8 NPTF female x 3/4 NPTF male | Steel |
| 12989 | 1/2 NPTF female x 1/4 NPTF male | Steel |
| 67171 | 1/2 NPTF female x 3/4 NPTF male | Steel |
| 12287 | 1/2-27 NPTF female x 1/2 NPTF male | Steel |

Pipe Fittings—Nipples

For supply and feed lines.

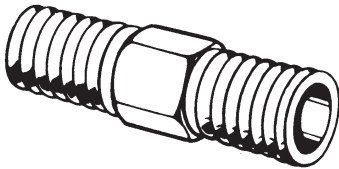

| Part No. | Thread / in. | Style | Construction |
|----------|-------------------------------------|-------|---------------------|
| 10130 | 1/8 NPTF male x 1/8 NPTF male | Hex | Steel |
| 67371 | 1/8 NPTF male x 1/8 NPTF male | Close | Brass |
| 10772 | 1/8 NPTF male x 1/4 NPTF male | Hex | Steel |
| 10199 | 1/8 NPTF male x 1/2-27 NPTF male | Hex | Brass |
| 10462 | 1/4 NPTF male x 1/4 NPTF male | Hex | Steel |
| 10462-9 | 1/4 NPTF male x 1/4 NPTF male | Hex | Stainless Steel-303 |
| 10198 | 1/4 NPTF male x 1/2-27 NPTF male | Hex | Brass |
| 10773 | 3/8 NPTF male x 1/4 NPTF male | Hex | Steel |
| 14727 | 3/4 NPTF male x 1/4 NPTF male | Hex | Steel |
| 10540 | 3/8 NPTF male x 3/8 NPTF male | Hex | Steel |
| 11107 | 3/8 NPTF male x 3/4 NPTF male | Hex | Steel |
| 11197 | 1/2 NPTF female x 1/2 NPTF male | Hex | Steel |
| 12957 | 1/2 NPTF male x 1/2-27 NPTF male | Hex | Steel |
| 12106 | 1/2 NPTF male x 3/4 NPTF male | Hex | Steel |
| 10202 | 1/2-27 NPTF male x 1/2-27 NPTF male | Hex | Brass |

Pipe Fittings—Couplings

For supply and feed lines.

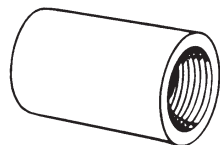

| Part No. | Thread / in. | Construction |
|----------|-----------------------------------|--------------|
| 67063 | 1/8 NPTF female x 1/8 NPTF female | Steel |
| 67360 | 1/8 NPTF female x 1/8 NPTF female | Brass |
| 67179 | 1/2 NPTF female x 1/2 NPTF female | Forged Steel |

Pipe Fittings—Reducing Couplings

For supply and feed lines.

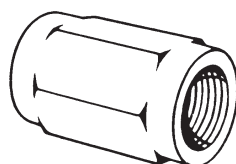

| Part No. | Thread / in. | Construction |
|----------|--------------------------------------|----------------|
| 11852 | 1/8 NPTF female x 1/2-27 NPTF female | Steel |
| 67094 | 1/4 NPTF female x 3/8 NPTF female | Malleable Iron |
| 67176 | 1/4 NPTF female x 1/2 NPTF female | Forged Steel |
| 10522 | 1/4 NPTF female x 1/2-27 NPTF female | Brass |
| 67296 | 3/8 NPTF female x 1/2 NPTF female | Forged Steel |

Pipe Fittings—Street Ells

For supply and feed lines.

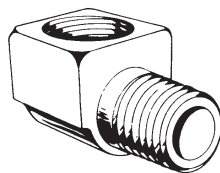

| Part No. | Thread / in. | Construction |
|----------|---------------------------------|---------------------|
| 67368 | 1/8 NPTF female x 1/8 NPTF male | Brass |
| 67368-9 | 1/8 NPTF female x 1/8 NPTF male | Stainless Steel-304 |
| 67054 | 1/4 NPTF female x 1/4 NPTF male | Brass |
| 67358 | 3/8 NPTF female x 3/8 NPTF male | Brass |
| 67074 | 1/2 NPTF female x 1/2 NPTF male | Malleable Iron |
| 67062 | 3/4 NPTF female x 3/4 NPTF male | Malleable Iron |

Pipe Fittings—Tees

For supply and feed lines.

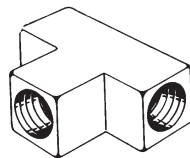

| Part No. | Thread / in. | Construction |
|----------|-----------------------------------|---------------------|
| 67011 | 1/8 NPTF female x 1/8 NPTF female | Brass |
| 67102 | 1/4 NPTF female x 1/4 NPTF female | Brass |
| 67102-9 | 1/4 NPTF female x 1/4 NPTF female | Stainless Steel-304 |
| 243373 | 1/2 NPTF female x 1/2 NPTF female | Forged Steel |

Street Tee

| Part No. | Description |
|----------|---|
| 67448 | 1/8" NPT male x 1/8" NPT female x 1/8" NPT female |

Pipe Fittings—Crosses

For supply and feed lines.

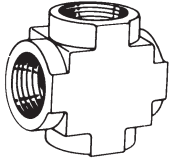

| Part No. | Thread / in. | Construction |
|----------|--------------|--------------|
| 67362 | 1/8 NPTF | Brass |

Pipe Fittings—Adapter Unions

For supply and feed lines.

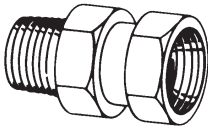

| Part No. | Thread / in. | Construction |
|----------|--|--------------|
| 66649 | 1/8 NPSM female swivel x 1/8 NPTF male | Steel |
| 66645 | 1/4 NPSM female swivel x 1/4 NPTF male | Steel |
| 66842 | 3/8 NPSM female swivel x 3/8 NPTF male | Steel |
| 66883 | 1/2 NPSM female swivel x 1/2 NPTF male | Steel |
| 69375 | 1 NPTF female swivel x 1 NPTF male | Steel |

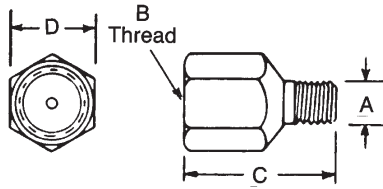

Pipe Fittings—Straight Adapters

For supply and feed lines. Carbon steel.

| Part No. | A in. | B in. | C in. | D in. |
|----------|---------|----------|-------|-------|
| 20024 | 1/4-28 | 1/8 NPSF | 7/8 | 1/2 |
| 66648 | 5/16-24 | 1/8 NPTF | 31/32 | 9/16 |

Metric

| Part No. | A in. | B in. | C in. | D in. |
|----------|---------|--------|-------|------------|
| 103307E | M6 x 1 | 1/4-28 | .56 | .393/.472* |
| 103308E | M8 x 1 | | | |
| 103309E | M10 x 1 | | | |

* Hex material may vary.

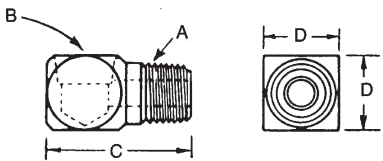

Pipe Fittings—90° Adapters

For supply and feed lines. Carbon Steel.

| Part No. | A in. | B in. | C in. | D in. |
|----------|--------|----------|--------|--------|
| 20026 | 1/4-28 | 1/8 * | 13/16 | 1/2 |
| 20029 | 1/8 * | 1/8 ** | 1 | 1/2 |
| 20031 | 1/8 * | 1/8 * | 13/16 | 1/2 |
| 20012 | 1/4 * | 1/4 NPTF | 1 1/16 | 1 1/16 |

* PTF special extra short. ** SAE short.

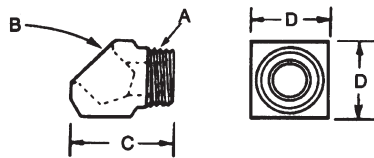

Pipe Fittings—45° Adapters

For supply and feed lines. Carbon Steel.

| Part No. | A in. | B in. | C in. | D in. |
|----------|--------|--------|--------|-------|
| 20028 | 1/8 ** | 1/8 ** | 1 | 1/2 |
| 247616 | 1/4-28 | 1/8 * | 1 1/16 | 1/2 |

* PTF special extra short. ** SAE short.

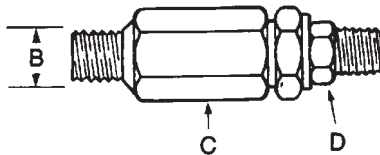

Supply Line Swivels—Straight Swivels (one swivel section)

For lubricant supply lines. Swivels have steel bodies and nitrile packing.

| Part No. | A in. | B in. | C in. | D in. | Working Pressure |
|----------|----------|----------|-------|--------|----------------------|
| 82080 | 1/2-27 | 1/2-27 | 7/8 | 9/16 | 5000 psig 340 bar |
| 83938 | 1/4 NPTF | 1/4 NPTF | 7/8 | 9/16 | |
| 81728 | 3/8 NPTF | 1/2 NPTF | 1 1/4 | 1 1/16 | |
| 82072 | 1/2 NPTF | 1/2 NPTF | 1 1/4 | 7/8 | |

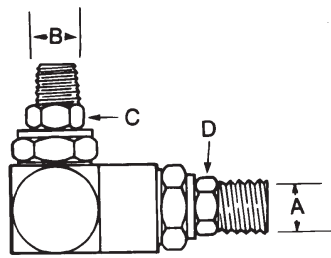

Supply Line Swivels—90° Angle Swivels (one swivel section)

For lubricant supply lines. Swivels have steel bodies and nitrile packing.

| Part No. | A in. | B in. | C in. | D in. | Working Pressure |
|----------|----------|----------|-------|-------|----------------------|
| 81386 | 1/8 NPTF | 1/2-27 | 9/16 | 7/16 | 5000 psig 340 bar |
| 81723 | 1/8 NPTF | 1/8 NPTF | 5/8 | 7/16 | |
| 81974 | 1/2-27 | 1/4 NPTF | 9/16 | 9/16 | |
| 82251 | 1/8 NPTF | 1/8 NPTF | 7/16 | 7/16 | |
| 82087 | 1/2 NPTF | 1/2 NPTF | 7/8 | 7/8 | |

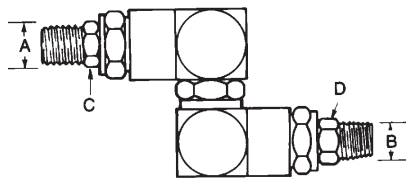

Supply Line Swivels—Universal Swivels (three swivel sections)

For lubricant supply lines. Swivels have steel bodies and nitrile packing.

| Part No. | A in. | B in. | C in. | D in. | Working Pressure |
|----------|----------|----------|-------|--------|----------------------|
| 82252 | 1/8 NPTF | 1/8 NPTF | 7/16 | 7/16 | 5000 psig 340 bar |
| 81387 | 1/4 NPTF | 1/2-27 | 9/16 | 9/16 | |
| 83594 | 1/4 NPTF | 1/4 NPTF | 9/16 | 9/16 | |
| 81729 | 1/2 NPTF | 3/8 NPTF | 7/8 | 1 1/16 | |
| 82073 | 1/2 NPTF | 1/2 NPTF | 7/8 | 7/8 | |

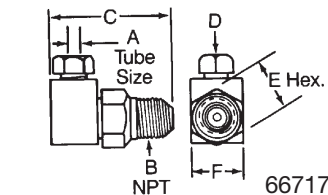

Feed Line Swivels—90° Angle Swivels

For lubricant feed lines. All models have a single swivel section and Buna N seals unless noted otherwise.

| Part No. | A Inlet in. | B Outlet in. | C Length in. | D Hex in. | E Hex/Flat in. | F Flat in. |
|----------|---------------|--------------|--------------|-----------|----------------|------------|
| 66717 | 1/8 | 1/8 | 1 1/4 | 5/16 | 9/16 | 1/2 |
| *66717-9 | O.D. Tube | NPTF (M) | | | | |
| 91048 | 1/8 | 1/8 | 1 1/4 | N/A | 9/16 | 1/2 |
| *91048-9 | NPTF (F) | NPTF (M) | | | | |
| *83722 | 1/8 O.D. Tube | 1/4 -28 | 15/16 | 15/16 | 3/8 | |
| 83822 | 1/8 NPTF (F) | 1/8 NPTF (F) | 1 3/8 | 1/2 | 3/8 | |

* 303 Stainless Steel

Note: Models 91048 & 91048-9 are similar in appearance to 66717 & 66717-9, but do not include direct tube connections.

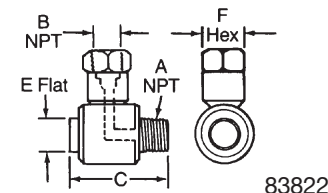
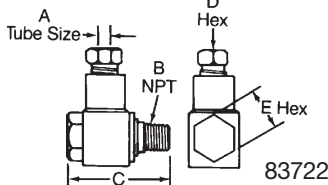

Feed Line Swivels—Straight Swivels

For lubricant feed lines. All models have a single swivel section and Buna N seals unless noted otherwise.

| Part No. | A Thread in. | B Thread in. | C Length in. | D Hex in. | E Flat in. |
|----------|--------------|--------------|--------------|-----------|------------|
| 91308 | 1/8 | 1/8 | 1 3/8 | 9/16 | |
| *92131 | NPTF (F) | NPTF (M) | | | |
| 81606 | 1/8 NPTF (F) | 1/8 NPT (M) | 1 1/2 | 3/4 | 15/32 |

* With Viton® seals.

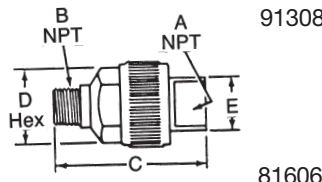
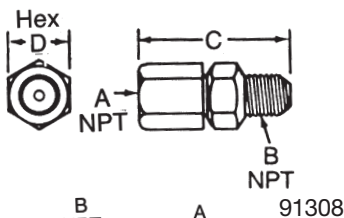

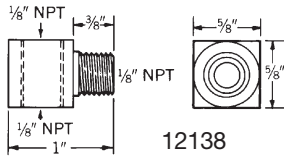

12138

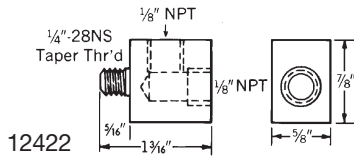

12422

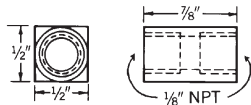

12612

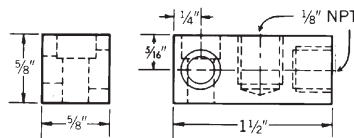

81583

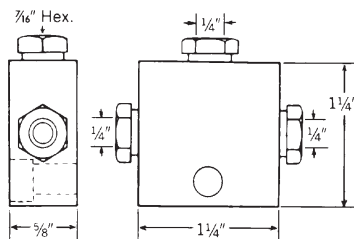

82225

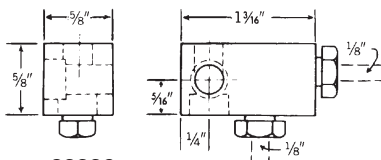

82226

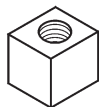

270928



249851



249850

Anchor and Junction Blocks

Securely fasten flexible supply and feed lines.

| Part No. | Description | Use with Series Injectors* | Installation Method |
|----------|----------------|----------------------------------|----------------------------------|
| 12138 | Anchor Block | SL-1, 11, 32, 33, 41, 42, 43, 44 | Use 1 1/32 drill and 1/8 NPT tap |
| 12422 | | SL-1, 11, 32, 33, 41, 42, 43, 44 | Use No. 3 drill and 1/4 -28 tap |
| 81583** | | SL-1, 11, 32, 33, 41, 42, 43, 44 | Use No. 7 drill and 1/4 -20 tap |
| 82226** | | SL-32, 33, 42, 43 | Use No. 7 drill and 1/4 -20 tap |
| 82225** | Junction Block | SL-32, 33, 42, 43 | Use No. 7 drill and 1/4 -20 tap |

* Can also be used with corresponding size supply and feed lines on Modular Lube II and Quicklub systems.

** Includes 50521 mounting screw.

Stand Offs for Mounting SSV Valves, P-Clamps and Angle Iron

| Part No. | Description |
|----------|---|
| 252807 | Divider valve mounting block |
| 249987 | 6mm bolt to be used with the 252807 |
| 249850 | 12mm round stand off |
| 270928 | 12mm square stand off |
| 249848 | 12mm x 5/8" long bolt to be used with 249850 and 270928 |
| 249851 | 10mm round stand off |
| 249849 | 10mm x 5/8" long bolt to be used with 249851 |