

ORSCO® Lubrication Systems

Extends Chain Life

- Reduced Oil Consumption
- Short-term ROI
- Cleaner Conditions
- Less Downtime
- Overall Energy Savings

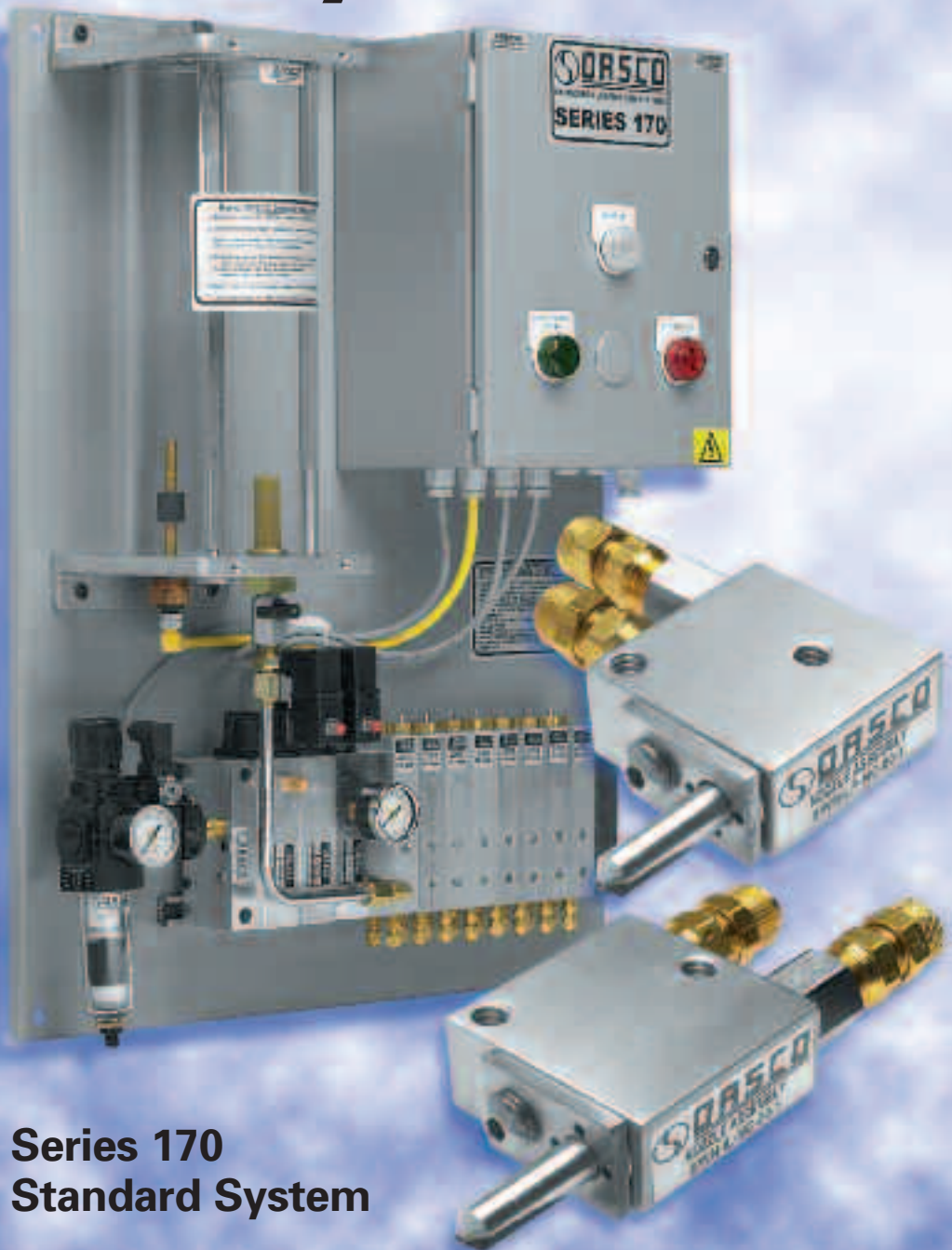

Series 170
Standard System

ORSCO® Series 170

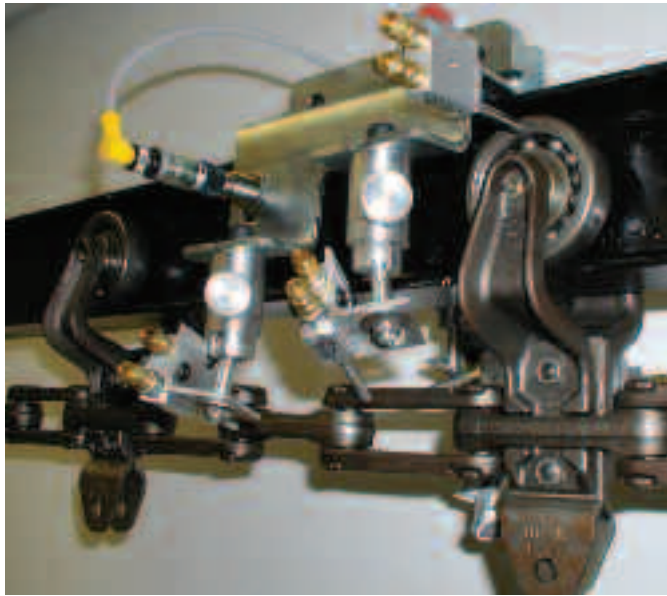

The secret of the ORSCO Series 170 is its unique ability to provide the right amount of lubricant, at the right location and at the right time, by delivering a small amount of lubricant on a continual and controlled basis. There are no worries about reliability or durability as the ORSCO Series 170 has been tested at the maximum injector rate for millions of cycles.

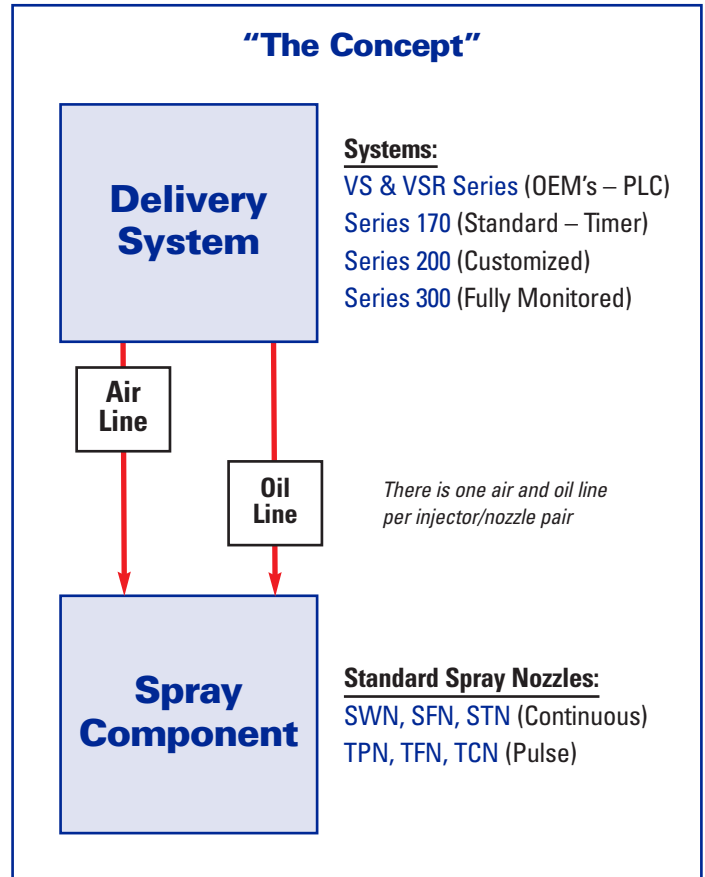

“Over 60 percent of mechanical failures relate directly to poor or improper lubrication practices.”*

Spray Nozzle Advantage: “Cleaning Effect”

Applying lubricant in a continuous fashion provides the best on-going continual maintenance for your chain and keeps all the moving parts as clean as possible, as shown.

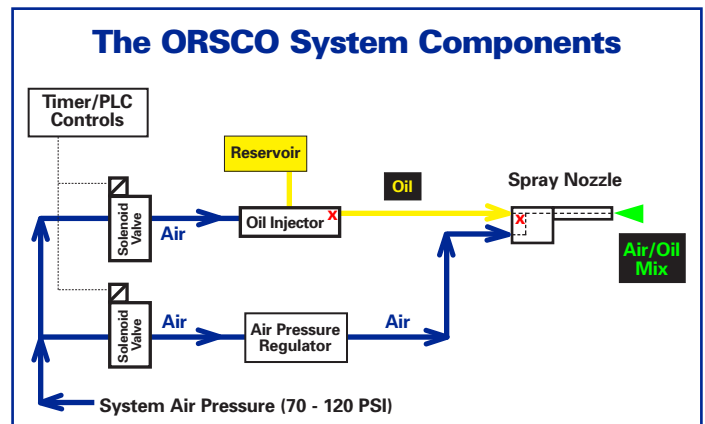

* Typical return on investment is less than six months

Product Features

A Complete System

- OEM or installed on site
- Combines controls, valves stack and reservoir

High-Output Capacity

- Half drop (.015 cc)
- Two drop (.060 cc)
- Can deliver up to four drops per second (combined injector output) for large amounts of lubrication

Compact, Easy to Maintain

- Manifold design, compact
- Can service part of assembly if necessary
- Easy to set up

Applications

- High-speed conveyors
- Baking and processing ovens
- Overhead conveyors
- Lubricate up to 16 points with one system
- Numerous control options

Features & Benefits

- ◆ Fixed volume delivery improves lubricant control
- ◆ High injector cycle rate (up to 1 Hz) can accommodate applications requiring large amounts of lubricant
- ◆ Three-piece reservoir design makes fluid levels easy to see and the component easy to clean and field repair
- ◆ Compact modular design with minimal external piping is ideal for Original Equipment Manufacturer (OEM) applications
- ◆ Patented spray nozzle design
- ◆ Easily adaptable modular package

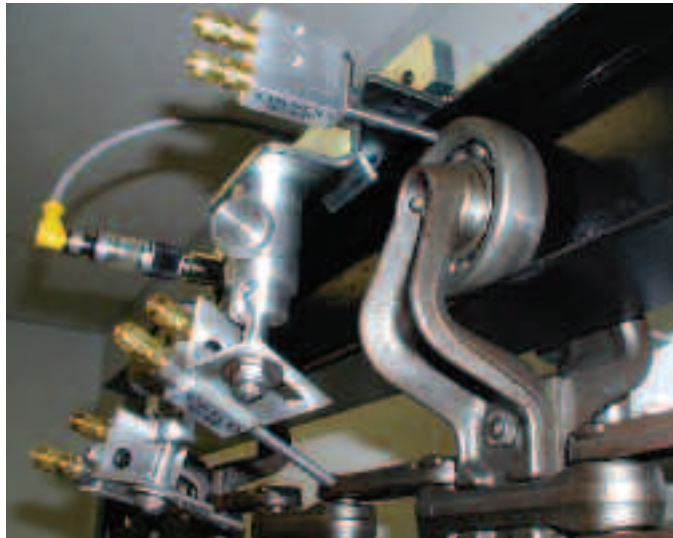

MODULAR PACKAGES FOR OEMs AND END-USERS

VS Series

The valve stack, the heart of the ORSCO family of lubrication products, comes standard with one control network per stack and feeds up to eight injectors. This is a great lubrication solution when matched with a customer's PLC and existing fluid source.

* Filter pressure switch is not standard with the VS Series product

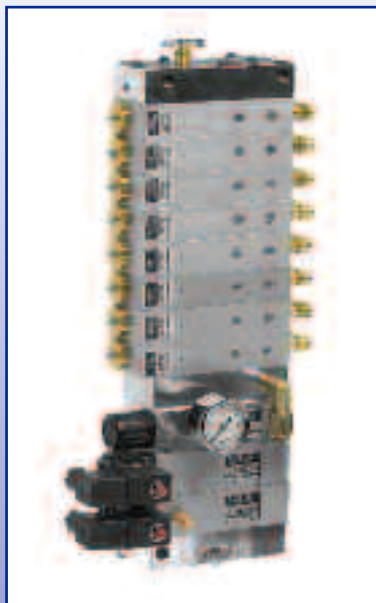

Valve Stack Series

VSR Series

By adding a reservoir and a filter pressure switch, this package comes ready to work with a customer's timer or PLC.

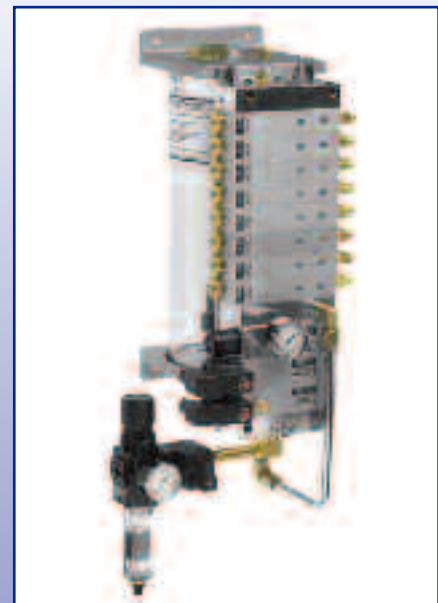

Valve Stack-Reservoir Series

ORSCO®

Ideal for Many Industries



Pulp & Paper Industry



Beverage Industry



Textile Industry (tenter frame applications)

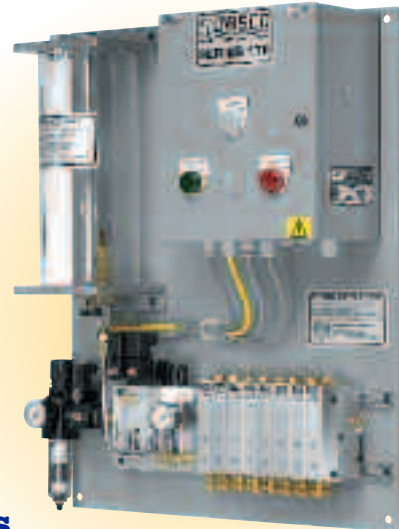

Series 170 System

A standard and easy-to-install system for up to 16 lubrication points with multiple variations to choose.

Orsco Series 200 & 300

Series 200 is available for custom solutions requiring over 16 points of lubrication.

Series 300 is for real-time pressure monitoring of lubrication system.

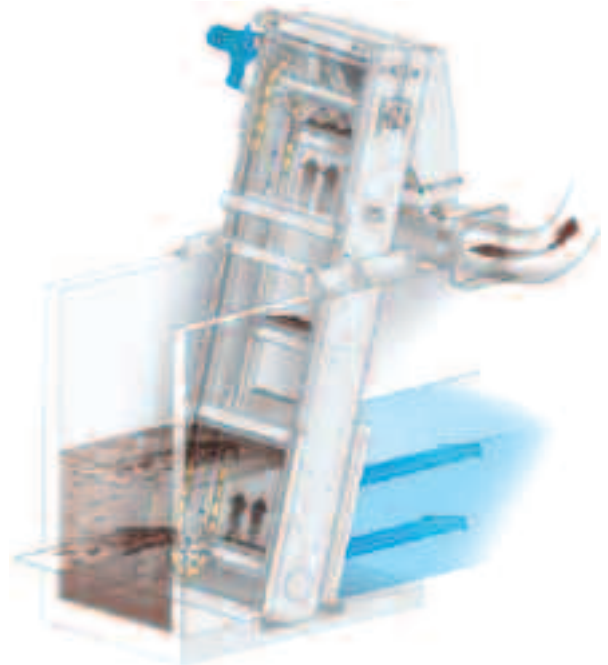

Waste Water Bar Screen

Products

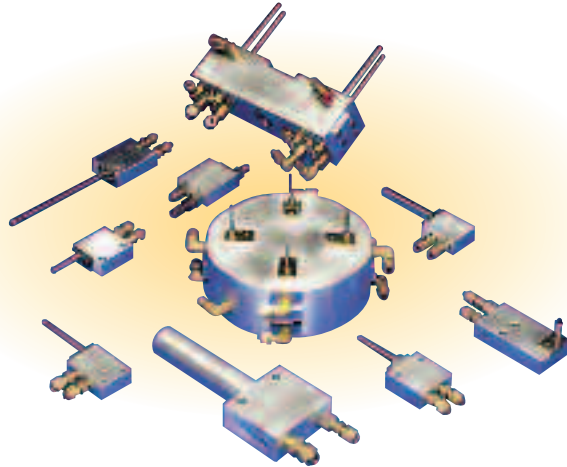

“Customized” Oil Spray Nozzles

If necessary, ORSCO will custom design nozzles or systems specific to the particular application.

Industrial Applications

Industry	Series 170	Series 200	Series 300
Assembly	◆	◆	◆
Automotive	◆	◆	◆
Baking	◆	◆	
Beverage	◆	◆	
Fiberglass	◆	◆	
Food Processing	◆	◆	
Gypsum	◆	◆	
Industrial Ovens	◆	◆	
Machine Tool	◆	◆	◆
Material Handling	◆	◆	
Plastic	◆	◆	◆*
Pulp & Paper	◆	◆	
Textile	◆	◆	◆*
Waste Water	◆	◆	

* Tenter frame applications

At ORSCO . . .

We don't make lubricants,
we make lubricants work better!

We don't make chains,
we make chains last longer!

We don't make machines,
we make machines more productive!

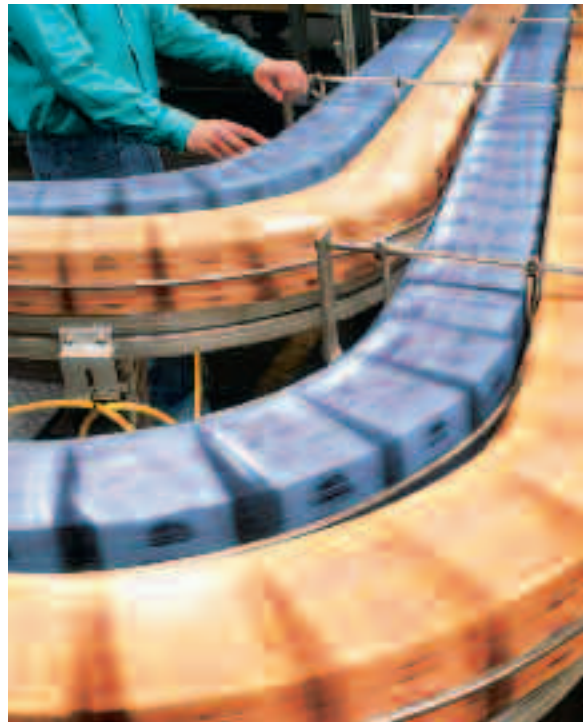

Material Handling Industry



Food Processing Industry



Baking Industry

ORSCO®

Patented Precision Delivery Nozzles

Choose from three tip lengths and three spray patterns for versatility in any continuous spray design application. These nozzles feature 1/4-20 tapped (#10 screw clearance) mounting holes and durable aluminum construction.

Part Number: SWN - IL - NC - 90 - 2 (Continuous Spray)
 TPN - LP - NC - 00 - 3 (Pulse Spray)

Standard Nozzles:

SWN (Continuous Spray)
 TPN (Pulse Spray)

Body Style:

IL In Line
 SS-IL Stainless Steel In Line
 LP Low Profile
 SS-LP Stainless Steel Low Profile

Fittings:

NC Nylon Compression Ftg.—Standard
 NY Nylon Push In Tube Ftg.
 CS Carbon Steel Ftg. (Steel Tubing)
 SS Stainless Steel Ftg. (Steel Tubing)
 XX No Fittings

Oil Lines:

Nylon—3/16" O.D. Tubing
 Steel Tube—1/8" O.D. Tubing

Air Lines:

Nylon—1/4" O.D. Tubing
 Steel Tube—1/4" O.D. Tubing

Tip Length:

1 One Inch
 2 Two Inch
 3 Three Inch

Spray Pattern Angle:

00 0° (straight)
 45 45°
 90 90°

Continuous-Spray Nozzle

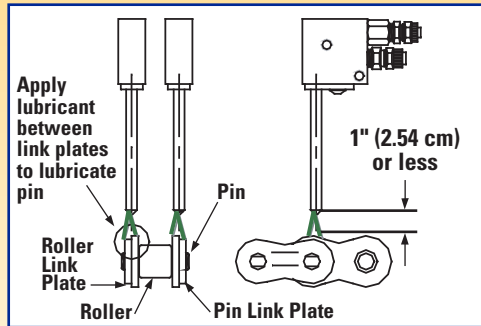
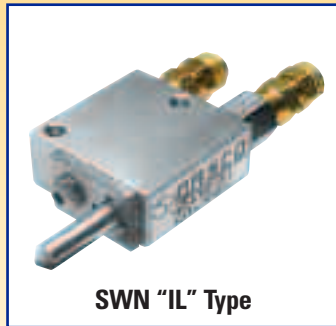

Continuous-Spray Nozzle

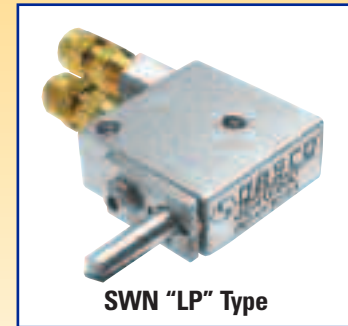

Shown below are graphic illustrations of other popular nozzle families.



Pulse-Spray Nozzle
 Assembly applications & slow moving chains

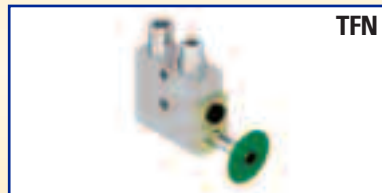

Pulse-Spray 360° Fan Nozzle
 Bore lube & general assembly applications



Pulse-Spray Cone Nozzle
 Engine & general assembly applications



Continuous-Spray Nozzle
 Chain/gears/exposed bearings/
 assembly applications



Continuous-Spray 120° Fan Nozzle
 Metal stamping/metal forming/
 food applications



Continuous-Spray High-Flow Nozzle
 Spindle applications

For custom nozzle design, contact your ORSCO representative.

Packaged Systems

170 Series

A standard and easy-to-install system for up to 16 lubrication points. Systems include an internal timer to control injector cycle rate. *Dual network indicates that half of the lubrication points are controlled by their own timer. Package includes: Appropriate number of spray nozzles of the type SWN-LP-NC-00-3, stainless steel nozzle mounting bracket and 25' nylon lines per lubrication point.

Series 170 Lubrication Systems				
Part number	Injector size**	No. of Networks	No. of Injectors	Voltage**** (USD)
170-512AO	0.015	1	2	120 VAC
170-514AO	0.015	1	4	120 VAC
170-524AO	0.015	2	4	120 VAC
170-528AO	0.015	2	8	120 VAC

NOTE:

** For double-drop injectors replace “5” with a “2” (i.e., #170-214AO)

**** For 24VDC voltage replace “A” with a “D” (i.e., #170-524DO)



VSR Series

ORSCO valve stack with reservoir and filter regulator/pressure switch. The system comes ready to work with a customer’s timer or PLC. Package includes: Appropriate number of spray nozzles of the type SWN-LP-NC-00-3, stainless steel nozzle mounting bracket and 25' nylon lines per lubrication point.

Series VSR Lubrication Systems				
Part number	Injector size**	No. of Networks	No. of Injectors	Voltage****
VSR-512AO	0.015	1	2	120 VAC
VSR-514AO	0.015	1	4	120 VAC
VSR-524AO	0.015	2	4	120 VAC
VSR-528AO	0.015	2	8	120 VAC

NOTE:

** For double-drop injectors replace “5” with a “2” (i.e., #VSR-214AO)

**** For 24VDC voltage replace “A” with a “D” (i.e., #VSR-524DO)

PLEASE CONTACT ORSCO TO QUOTE YOUR SPECIFIC APPLICATION

Other Automated Lubrication Systems (ALS)

EOS System®

A low-cost, economical system for precise metered quantities of oil to reduce chain and sprocket wear.



VSP System

A pneumatic-only controlled VSR made especially for applications prohibiting the use of electrical systems.



Accessories

Spring-loaded bracket and other accessories such as fiberglass enclosures and stainless steel fittings available only from Orsco.

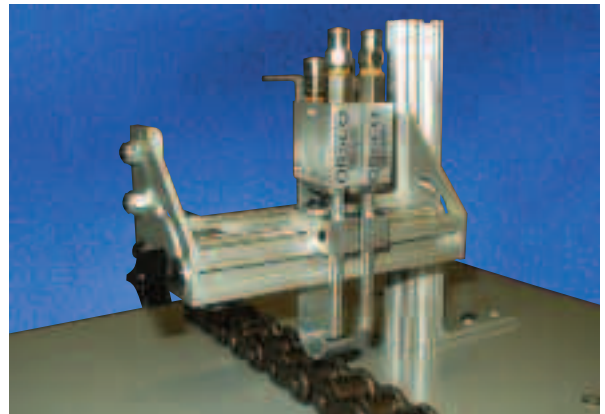

SOLUTIONS

contains new product information for Lincoln customers.

Please direct ideas, comments or questions to:

Lincoln

Marketing Communications,

Tel: (001) 314-679-4255 or 4401,

Fax: (001) 314-679-4359

www.lincolnindustrial.com

For the nearest authorized Lincoln sales and service representative, call:

For Technical and Sales Information:

ORSCO®, Inc.

14165 Rick Drive

Shelby Township, MI 48315 USA

(001) 586-997-0300

Fax (001) 586-997-2072

Americas:

St. Louis, Missouri

(001) 314-679-4200

Fax: (001) 314-679-4359

Asia/Pacific:

Singapore

(065) 65627960

Fax: (065) 65629967

Europe/Africa:

Walldorf, Germany

(049) 6227-33-0

Fax: (049) 6227-33-259



Lincoln Industrial Corp.
One Lincoln Way
St. Louis, MO 63120-1578

Phone (314) 679-4200
Fax (314) 679-4359
www.lincolnindustrial.com

Form 442919 (6/09)
© Copyright 2009
Printed in USA